

# Models PT3-1-45 & PT3-2-45

## Indoor Voltage Transformers Medium Voltage

### Accuracy Class

0.3 WX, 0.6 MY, 1.2 Z at 100 % rated voltage with 120 V based ANSI burden.

0.6 WX, 1.2 MY at 58 % rated voltage with 69.3 V based ANSI burden.

### Frequency

60 Hz.

### Maximum System Voltage

5.6 kV, BIL 45 kV.

### Thermal Rating

600 VA 30 °C. amb.  
400 VA 55 °C. amb.

### Specifications

The core and coil assembly is encased in a plastic enclosure and vacuum encapsulated in polyurethane resin.

Switch gear style is similar to fused style. No fuse or fuse clip is provide, but inserts for fuse clips are supplied.

Approximate weight 20 lbs., unfused.



REGULATORY AGENCY APPROVALS



Manufactured to meet the requirements of ANSI/IEEE C57.13.

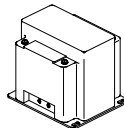
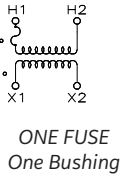
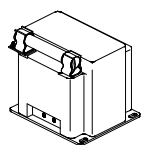
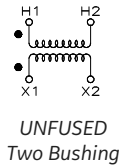
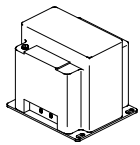

SWITCHGEAR  
STYLE  
Two Bushing

## PT3

Two Bushings (a)				Catalog Numbers			
Group	Primary Voltage	Ratio	Secondary Voltage	Unfused	Fuses	Fuse Clips Only (d)	Switchgear Style
1	840	7:1	120	PT3-2-45-841	-	-	-
1	1,200	10:1	120	PT3-2-45-122	-	-	-
1	2,400	20:1	120	PT3-2-45-242	PT3-2-45-242FF	PT3-2-45-242CC	PT3-2-45-242SS
2	3,300	30:1	110 - 50 Hz	PT3-2-45-332	PT3-2-45-332FF	PT3-2-45-332CC	PT3-2-45-332SS
2	4,200	35:1	120	PT3-2-45-422	PT3-2-45-422FF	PT3-2-45-422CC	PT3-2-45-422SS
2	4,800	40:1	120	PT3-2-45-482	PT3-2-45-482FF	PT3-2-45-482CC	PT3-2-45-482SS

## PT3

One Bushing (a)				Catalog Numbers			
Group	Primary Voltage	Ratio	Secondary Voltage	R <sub>FR</sub> (c)	Fuses	Fuse Clips Only (d)	Switchgear Style
4A	2,400	20:1	120	190	PT3-1-45-242F	PT3-1-45-242C	PT3-1-45-242S
4B	4,200	35:1	120	190	PT3-1-45-422F	PT3-1-45-422C	PT3-1-45-422S
AB	4,800	40:1	120	190	PT3-1-45-482F	PT3-1-45-482C	PT3-1-45-482S



## Models PT3--1--45 & PT3--2--45

### Recommended Minimum Spacings

**A** = Unit to Unit = 0.75" minimum.

**B** = HV to Ground in air = 3.00" minimum.

Recommended spacing are for guidance only. User needs to set appropriate values to assure performance for high potential test, impulse test, high humidity, partial discharge, high altitude, and other considerations like configuration.

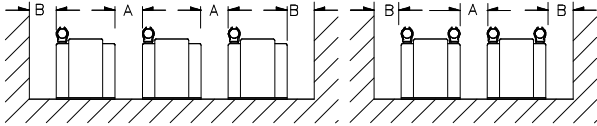

### Circle Diagram

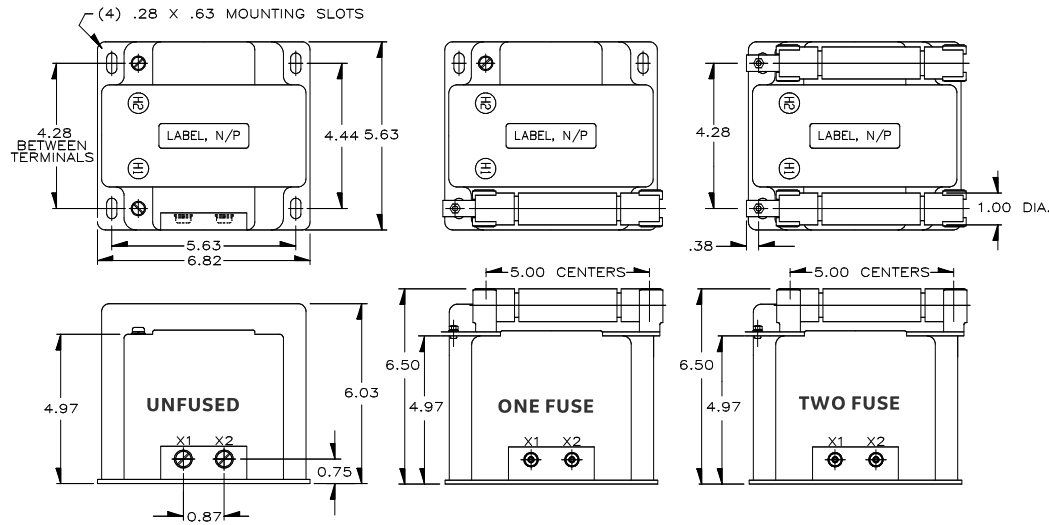
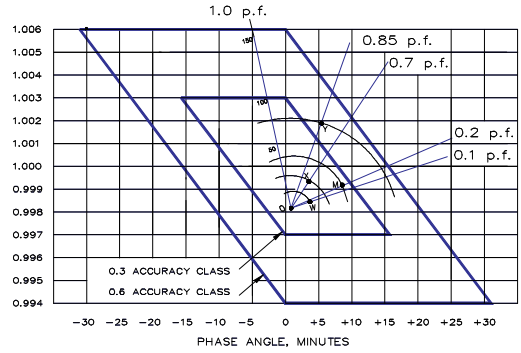

The circle diagram can be used to predict the performance of a transformer for various loads and power factors. A convenient scale of volt-ampere is shown on the unity power factor line (u.p.f.) and commences at the zero or no-load locus. To use the diagram, measure the known V.A. and scribe an arc about the "Zero" locus of a length that contains the angle of the burden power factor. The point at which the arc terminates is the error locus in phase angle minutes and ratio correction factor.

## PT3

Fuse for Model PT3 Transformers	Ratings kV	Interrupting Amperes (Sym)	Suggested Rating Continuous Amperes	Cap Dia. Inches (a)	Length Inches	Clip Centers Inches
2400:120V	5.5	45,000	2.0E	1.0	5.63	5.00
3300:110V	5.5	45,000	2.0E	1.0	5.63	5.00
4200:120V	5.5	45,000	1.0E	1.0	5.63	5.00
4800:120V	5.5	45,000	1.0E	1.0	5.63	5.00

(a) Two fuse transformers should not be used for Y connections. It is preferred practice to connect one lead from each voltage transformer directly to the neutral terminal, using a fuse in the line side of the primary only. By using this connection a transformer can never be made "live" from the line side by reason of a blown fuse in the neutral side. For continuous operation the transformer primary voltage should not exceed 110% of rated value.

(b) Voltage transformers connected line-to-ground cannot be considered to be grounding transformers and must not be operated with the secondaries in closed delta because excessive currents may flow in the delta.

(c) See page 32, item 1 for ferroresonance considerations. Values in table are in ohms. Note: It is recommended that system line-to-line voltage not exceed the transformer maximum system voltage level.

(d) Fuse clips noted as "CC" or "C" accept fuses with 1.0" Dia. caps and 5" clip centers. Fuses clips with a suffix "CCS" or "CS" accept fuses with 0.81 in. caps and 5 in. clip centers.

### GEGridSolutions.com

Grid-AIS-L4-ITL\_Model\_PT3-1482-2017\_07-EN. © Copyright 2017. General Electric Company and Instrument Transformers LLC reserve the right to change specifications of described products at any time without notice and without obligation to notify any person of such changes.

### Worldwide Contact Center

Web: [www.GEGridSolutions.com/contact](http://www.GEGridSolutions.com/contact)

Phone: +44 (0) 1785 250 070

USA and Canada: +1 (0) 800 547 8629

Europe, Middle East and Africa: +34 (0) 94 485 88 00

