

# Model CTWH7-150-T200

## Wound Primary Current Transformer Medium Voltage

### Application

Metering and relaying.

### Frequency

50-400 Hz

### Maximum System Voltage

36.5 kV, BIL 150 kV full wave.

### Continuous Thermal Current Rating Factor

1.50 at 30 °C., 1.33 at 55 °C.

2,000:5 - 1.33 at 30 °C., 1.00 at 55 °C.

2,500:5 and 3,000:5 - 1.00 at 30 °C.,  
0.85 at 55 °C.

### Specifications

Primary terminals are plated copper bars,  
configured as specified.

Secondary terminals are brass screws No.  
10-32 with one flatwasher and lockwasher.

Vacuum cast polyurethane resin.

Dual bars spacing is 1/2 inch.

Approximate weight 180 lbs.



Note: 200 kV BIL is available.  
Except for 3,000:5 ratio.

#### REGULATORY AGENCY APPROVALS



Manufactured to meet the requirements of ANSI/IEEE C57.13.

## Model CTWH7-150-T20

Catalog Number**	Current Ratio	Relay Class	ANSI Metering Class at 60 Hz					* Thermal Current Rating 1 Second RMS Amps
			B0.1	B0.2	B0.5	B0.9	B1.8	
CTWH7-150-T200-801-**	800:5	T200	0.3	0.3	0.3	0.3	0.3	87,000
CTWH7-150-T200-102-**	1,000:5	T200	0.3	0.3	0.3	0.3	0.3	133,000
CTWH7-150-T200-122-**	1,200:5	T200	0.3	0.3	0.3	0.3	0.3	133,000
CTWH7-150-T200-152-**	1,500:5	T200	0.3	0.3	0.3	0.3	0.3	266,000
CTWH7-150-T200-202-**	2,000:5	T200	0.3	0.3	0.3	0.3	0.3	266,000
CTWH7-150-T200-252-**	2,500:5	T200	0.3	0.3	0.3	0.3	0.3	266,000
CTWH7-150-T200-302-**	3,000:5	T200	0.3	0.3	0.3	0.3	0.3	358,000

\*With a burden of B0.1 or greater connected to the secondary

\*\*Specify primary bus arrangement number (1 through 8).

Approved for revenue metering by Industry Canada No. AE-0638 Rev. 1



# Model CT Model CTWH6-125-T200 WH6-125-T200 Wound Primary CT

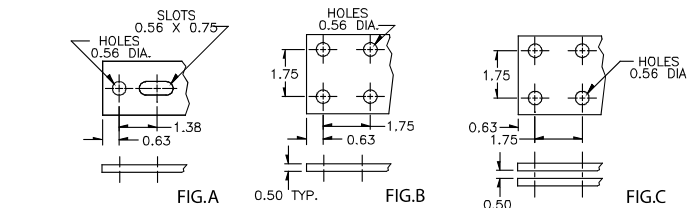
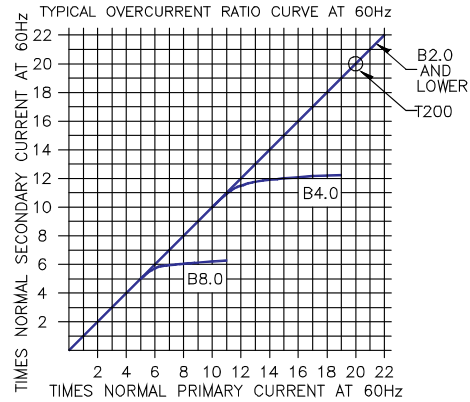
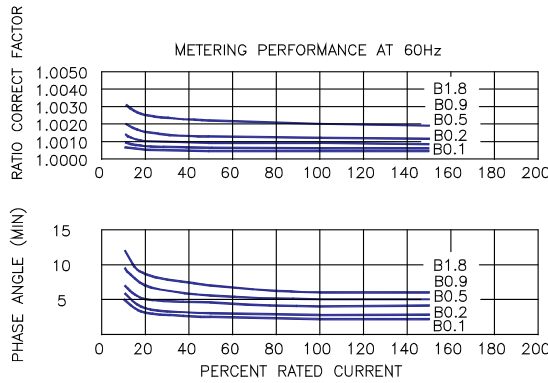

Ratio	Primary Terminals	Fig
800:5	One 1/2 X 2	A
1,000:5	One 1/2 X 3	B
1,200:5	One 1/2 X 3	B
1,500:5	Two 1/2 X 3	C
2,000:5	Two 1/2 X 3	C
2,500:5	Two 1/2 X 3	C
3,000:5	Two 1/2 X 4	C

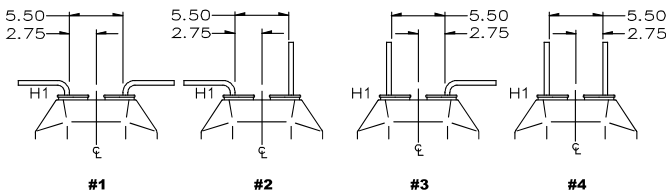

### Primary Bar Arrangements

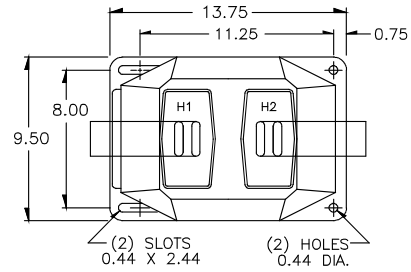
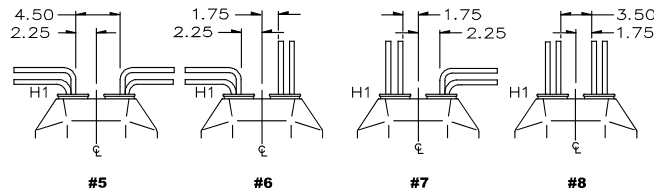

### RECOMMENDED MINIMUM SPACINGS

**A** = Unit to Unit = 8.50" minimum.

**B** = HV to Ground in Air = 8.50" minimum.

Recommended spacing are for guidance only. User needs to set appropriate values to assure performance for high potential test, impulse test, high humidity, partial discharge, high altitude, and other considerations like configuration.

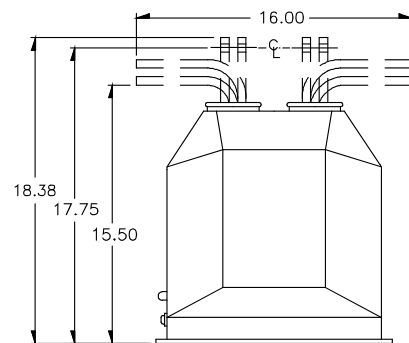
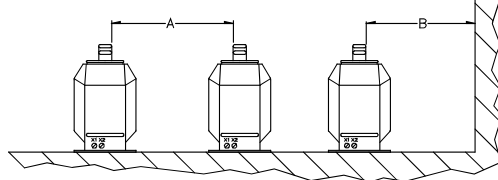

[GEGridSolutions.com](http://GEGridSolutions.com)

Grid-AIS-L4-ITL\_Model\_CTWH7-1443-2017\_08-EN. © Copyright 2017. General Electric Company and Instrument Transformers LLC reserve the right to change specifications of described products at any time without notice and without obligation to notify any person of such changes.

### Worldwide Contact Center

Web: [www.GEGridSolutions.com/contact](http://www.GEGridSolutions.com/contact)

Phone: +44 (0) 1785 250 070

USA and Canada: +1 (0) 800 547 8629

Europe, Middle East and Africa: +34 (0) 94 485 88 00

