

Model CTWH3-60-T100

Wound Primary Current Transformer Medium Voltage

Application

Metering and relaying.

Frequency

50-400 Hz

Maximum System Voltage

5.6 kV, BIL 60 kV.

Continuous Thermal Rating Factor

1.50 at 30 °C., 1.33 at 55 °C.
250:5, 1,000:5 and 1,200:5-
1.10 at 30 °C., 0.85 at 55 °C.

Specifications

Primary terminals are plated copper bars.
See chart next page for sizes. Secondary
terminals are brass screws No. 10-32 with
one flatwasher, lockwasher.

Vacuum cast in polyurethane resin.
Other ratios, secondary currents and dual
ratios are available. Refer to factory.

Approximate weight 41 lbs



REGULATORY AGENCY APPROVALS



Manufactured to meet the requirements of ANSI/IEEE C57.13.

Model CTWH3-60-T100

Catalog Number	Current Ratio	Relay Class	ANSI Metering Class at 60 Hz					** Thermal Current Rating 1 Second RMS Amps
			BO.1	BO.2	BO.5	BO.9	B1.8	
CTWH3-60-T100-050	5:5	T100	0.3	0.3	0.3	0.3	0.3	470
CTWH3-60-T100-100	10:5	T100	0.3	0.3	0.3	0.3	0.3	900
CTWH3-60-T100-150	15:5	T100	0.3	0.3	0.3	0.3	0.3	1,600
CTWH3-60-T100-200	20:5	T100	0.3	0.3	0.3	0.3	0.3	1,900
CTWH3-60-T100-250	25:5	T100	0.3	0.3	0.3	0.3	0.3	2,600
CTWH3-60-T100-300	30:5	T100	0.3	0.3	0.3	0.3	0.3	2,900
CTWH3-60-T100-400	40:5	T100	0.3	0.3	0.3	0.3	0.3	3,800
CTWH3-60-T100-500	50:5	T100	0.3	0.3	0.3	0.3	0.3	4,700
CTWH3-60-T100-750	75:5	T100	0.3	0.3	0.3	0.3	0.3	5,900
CTWH3-60-T100-101	100:5	T100	0.3	0.3	0.3	0.3	0.3	8,600
CTWH3-60-T100-151	150:5	T100	0.3	0.3	0.3	0.3	0.3	12,900
CTWH3-60-T100-201	200:5	T100	0.3	0.3	0.3	0.3	0.3	17,200
CTWH3-60-T100-251	250:5	T100	0.3	0.3	0.3	0.3	0.3	17,200
CTWH3-60-T100-301	300:5	T100	0.3	0.3	0.3	0.3	0.3	34,500
CTWH3-60-T100-401	400:5	T100	0.3	0.3	0.3	0.3	0.3	34,000
CTWH3-60-T100-601	600:5	T100	0.3	0.3	0.3	0.3	0.3	66,200
CTWH3-60-T100-801	800:5	T100	0.3	0.3	0.3	0.3	0.3	66,200
CTWH3-60-T100-102	1,000:5	T100	0.3	0.3	0.3	0.3	0.3	66,200
CTWH3-60-T100-122	1,200:5	T100	0.3	0.3	0.3	0.3	0.3	66,200

*With a burden of BO.1 or greater connected to the secondary.



Model CTWH3-60-T100 Wound Primary CT

Bar Sizes

Primary Current	Dimensions	
	A	B
5 to 250 A	0.25	1.50
300 to 1,200 A	0.38	2.00

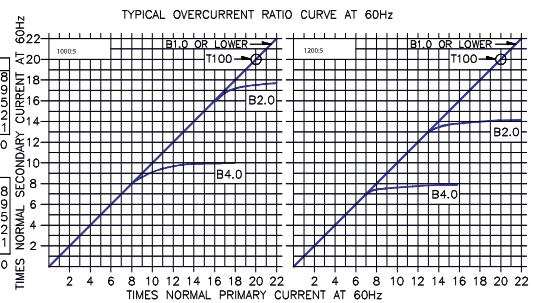
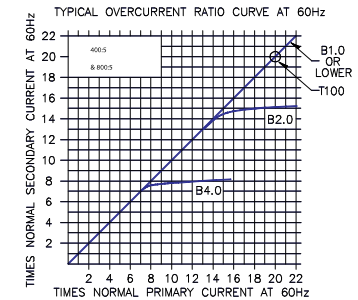
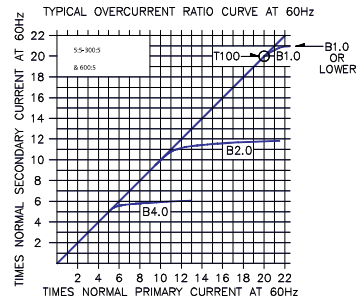
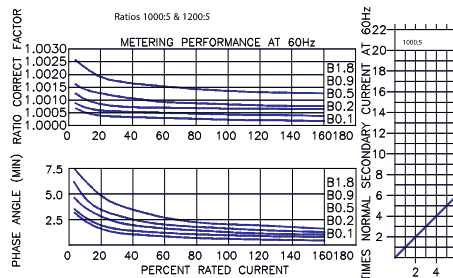
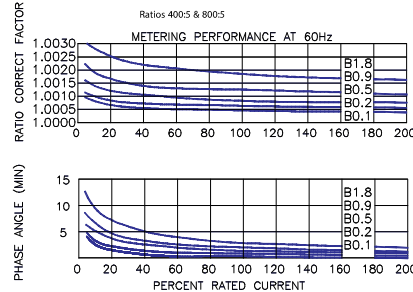
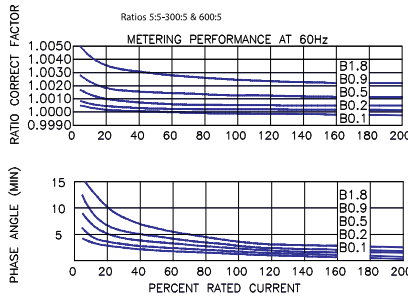

RECOMMENDED MINIMUM SPACINGS

A = Unit to Unit = 0.75" minimum.

B = HV to Ground in Air = 3.00" minimum.

Recommended spacing are for guidance only. User needs to set appropriate values to assure performance for high potential test, impulse test, high humidity, partial discharge, high altitude, and other considerations like configuration.

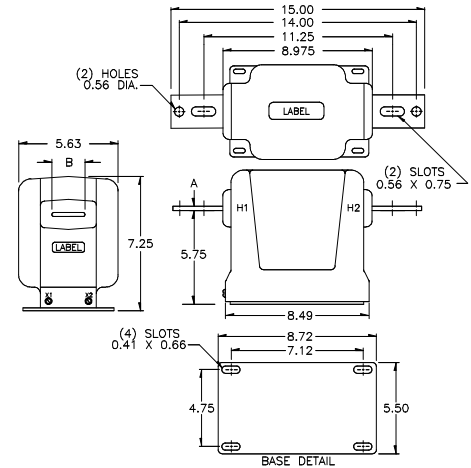
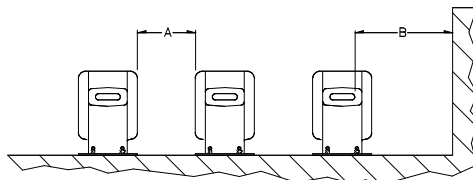

GEGridSolutions.com

Grid-AIS-L4-ITL_Model_CTWH3T100-1437-2017_06-EN. © Copyright 2017. General Electric Company and Instrument Transformers LLC reserve the right to change specifications of described products at any time without notice and without obligation to notify any person of such changes.

Worldwide Contact Center

Web: www.GEGridSolutions.com/contact

Phone: +44 (0) 1785 250 070

USA and Canada: +1 (0) 800 547 8629

Europe, Middle East and Africa: +34 (0) 94 485 88 00

