

GE
Grid Solutions

iSTAT M2x2

Standard Measurement Centre

M212, M232

Manual

Publication reference: M2x2/EN/M/F



1. SAFETY SECTION



This Safety Section should be read before commencing any work on the equipment.

1.1 Health and Safety

The information in the Safety Section of the product documentation is intended to ensure that products are properly installed and handled in order to maintain them in a safe condition. It is assumed that everyone who will be associated with the equipment will be familiar with the contents of the Safety Section.

1.2 Explanation of symbols and labels

The meaning of symbols and labels may be used on the equipment or in the product documentation, is given below.

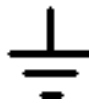
	
Caution: refer to product documentation	Caution: risk of electric shock
	
Protective/safety *earth terminal	Functional *earth terminal Note: This symbol may also be used for a protective/safety earth terminal if that terminal is part of a terminal block or sub-assembly e.g. power supply.

*NOTE: The term earth used throughout the product documentation is the direct equivalent of the North American term ground.

2. INSTALLING, COMMISSIONING AND SERVICING



Equipment connections

Personnel undertaking installation, commissioning or servicing work on this equipment should be aware of the correct working procedures to ensure safety. The product documentation should be consulted before installing, commissioning or servicing the equipment.

Terminals exposed during installation, commissioning and maintenance may present a hazardous voltage unless the equipment is electrically isolated.

If there is unlocked access to the rear of the equipment, care should be taken by all personnel to avoid electrical shock or energy hazards.

Voltage and current connections should be made using insulated crimp terminations to ensure that terminal block insulation requirements are maintained for safety. To ensure that wires are correctly terminated the correct crimp terminal and tool for the wire size should be used.

Before energising the equipment it must be earthed using the protective earth terminal, or the appropriate termination of the supply plug in the case of plug connected equipment. Omitting or disconnecting the equipment earth may cause a safety hazard.

The recommended minimum earth wire size is 2.5mm², unless otherwise stated in the technical data section of the product documentation.

Before energising the equipment, the following should be checked:

- Voltage rating, frequency and polarity
- VT ratio and phase sequence
- CT circuit rating and integrity of connections;
- Protective fuse rating;
- Integrity of earth connection (where applicable)
- Supply voltage

3. EQUIPMENT OPERATING CONDITIONS

The equipment should be operated within the specified electrical and environmental limits.

3.1 Current transformer circuits



Do not open the secondary circuit of a live CT since the high level voltage produced may be lethal to personnel and could damage insulation.

3.2 Insulation and dielectric strength testing



Insulation testing may leave capacitors charged up to a hazardous voltage. At the end of each part of the test, the voltage should be gradually reduced to zero, to discharge capacitors, before the test leads are disconnected.

3.3 Opening Enclosure



There are no customer replaceable PCB cards or components within the enclosure, so the enclosure should not be opened.

4. DECOMMISSIONING AND DISPOSAL



Decommissioning: The auxiliary supply circuit in the relay may include capacitors across the supply or to earth. To avoid electric shock or energy hazards, after completely isolating the supplies to the relay (both poles of any dc supply), the capacitors should be safely discharged via the external terminals prior to decommissioning.

Disposal: It is recommended that incineration and disposal to water courses is avoided. The product should be disposed of in a safe manner. Any products containing batteries should have them removed before disposal, taking precautions to avoid short circuits. Particular regulations within the country of operation, may apply to the disposal of lithium batteries.

5. TECHNICAL SPECIFICATIONS

5.1 Protective fuse rating

The recommended maximum rating of the external protective fuse for this equipment is 6A, Red Spot type or equivalent, unless otherwise stated in the technical data section of the product documentation.

Insulation class:	IEC 61010-1 : 2002 Class II EN 61010-1 : 2002 Class II	
Insulation Category (Over voltage):	IEC 61010-1 : 2002 Category II (600V), III (300V) EN 61010-1 : 2002 Category II (600V), III (300V)	
Environment:	IEC 61010-1 : 2002 Pollution degree 2 (600V), 3 (300V) EN 61010-1 : 2002 Pollution degree 2 (600V), 3 (300V)	Compliance is demonstrated by reference to generic safety standards.
Product Safety: 	72/23/EEC & 2006/95/EC EN 61010-1 : 2002	Compliance with the European Commission Low Voltage Directive. Compliance is demonstrated by reference to generic safety standards.

CONTENT

1.	SAFETY SECTION	1
1.1	Health and Safety	1
1.2	Explanation of symbols and labels	1
2.	INSTALLING, COMMISSIONING AND SERVICING	2
3.	EQUIPMENT OPERATING CONDITIONS	3
3.1	Current transformer circuits	3
3.2	Insulation and dielectric strength testing	3
3.3	Opening Enclosure	3
4.	DECOMMISSIONING AND DISPOSAL	3
5.	TECHNICAL SPECIFICATIONS	4
5.1	Protective fuse rating	4
6.	INTRODUCTION	9
6.1	General	9
6.2	Family	10
6.3	Measurements	10
6.4	Hardware features	10
6.5	Communication and inputs/outputs	11
6.6	User features	11
6.7	Applications	12
7.	SYSTEM MODES	13
7.1	Connection mode	13
7.1.1	Valid measurements	13
7.2	Power mode	15
7.3	Operating energy quadrants	15
8.	INSTRUMENTATION	17
8.1	Measurements	17
8.2	Glossary	17
8.3	Supported Measurements	19

8.3.1	Voltage	20
8.3.2	Current	20
8.3.3	Frequency	20
8.3.4	Harmonics (THD)	20
8.3.5	Power	20
8.3.6	Power factor	20
8.3.7	Energy	21
8.3.8	Maximum demands (MDs)	21
8.3.9	Thermal Average demands	21
9.	HARDWARE	22
9.1	Connections	22
9.2	Communications	22
9.3	Inputs and Outputs	23
9.3.1	Energy Pulse Outputs	23
9.3.2	Tariff (inputs)	23
9.3.3	Alarm outputs	24
9.4	Auxiliary Supply	24
10.	USER INTERFACE MENU STRUCTURE	25
10.1	Menu introduction	25
10.2	Measurement Navigation	27
10.3	Settings Navigation	29
10.4	Resets Navigation	31
10.5	Info Navigation	31
10.6	Installation Navigation	32
10.7	Default settings	32
11.	HARDWARE FUNCTIONS	33
11.1	Installation Wizard	33
11.2	Demo Cycling	36
12.	SETTINGS	38
12.1	Setting Navigation	38
12.2	General Navigation	38
12.3	LCD Navigation	40
12.4	Security Navigation	41
12.5	Energy Navigation	42
12.6	Inputs and Outputs	43
13.	COMMUNICATIONS	45
13.1	Communications ports	45
13.2	QDSP Setting and Monitoring Software	45
13.3	MODBUS	45

14.	TECHNICAL DATA	46
15.	WIRING DIAGRAMS AND CASE DIMENSIONS	50
16.	RELATED DOCUMENTS	54
17.	APPENDIX A: MODBUS PROTOCOL	55
17.1	Modbus communication protocol	55
17.2	Register Map for Actual Measurements	55
17.3	Register table for IEEE 754 Measurements	57
17.4	Register table for the normalized actual measurements	60
17.5	100% values calculations for normalized measurements	62
17.6	Register table for the basic settings	63
17.7	Data types decoding	64
<hr/>		
18.	APPENDIX B: CALCULATIONS & EQUATIONS	66
18.1	Definitions of symbols	66
18.2	Equations	66

BLANK PAGE

6. INTRODUCTION

6.1 General

The **iSTAT M2x2** is an easy to use standard measurement centre family aimed particularly at the medium voltage and industrial market segments throughout the world.

The **M2x2** measurement centre family integrates a number of measurements and metering functions in the same unit for power system management. The use of numerical technology achieves high accuracy over a wide dynamic measuring range for instantaneous and integrated power system parameters. The **M2x2** offers:

- A cost-effective solution for Medium Voltage and Industrial markets
- Modbus protocol for integrating into energy management and control systems.
- Setup and wrong connection wizards, demonstration screens and user customised display making the **M2x2** family user friendly.
- Multi-lingual menu (English, German, Danish, French, Italian, Spanish, Russian etc.)
- CE certification

The **M2x2** uses a software package called **QDSP**, it is suggested that the QDSP software is used when possible as it provides a simple interface for communicating with the product. A separate QDSP manual is available.

- **QDSP Standard** is used for setting and monitoring all of the iSTAT devices with communications, i400, i4Mx, i500, M2x1, **M2x2** and M2x3.
- **QDSP** also offers additional features such as upgrading from a secure web site for both the **QDSP** and the measurement centres.

KEY MESSAGES

- The iSTAT **M2x2** family is **easy to set and test**. In the substation world, more settings increase the chance of misapplication, and the potential for incorrect settings and inaccurate measurements. The iSTAT **M2x2** minimises the chance of an incorrect setting by using a setup wizard to help the operator configure the device.
- The iSTAT **M2x2** is an **economical** choice for measurements.
- The iSTAT **M2x2** offers **easy fitting**, by using embedded current transformers and a wrong connection warning for the current circuits. It uses a standard 96mm DIN case.
- **M2x2** allows connection to MODBUS based systems that are widely used by industrial and utility customers worldwide.

iSTAT – THE **standard** measurement platform

- Multiple advanced configuration features fitted as standard.
- Comprehensive choice of features for measurement applications.
- Flexible programmable software (**QDSP**) for straight forward product configuration.
- Complete and informative documentation, **QDSP** also includes help information.

Simple to fit, **simple** to set, **simple** to connect

- Standard 96mm DIN
- Set up Wizard to aid configuration
- Wrong connection warning
- Demonstration displays
- User defined customised displays

Advanced technology

- High sampling rate of 128 samples per cycle
- A frequency family of 16 2/3Hz, 45/65Hz or 400Hz

Economical

- Universal Power for all site situations
- Common case size permits retrofitting without major re-engineering of the panel.

6.2 Family

The **iSTAT M2x2** family provides:

- **M212** class 0.5 non-communicating Power and class 1 Energy Meter. The **M212** includes energy measurement in all four quadrants and is fitted with pulsed energy contact outputs and optional tariff inputs.
- **M232** class 0.5 communicating Measurement Centre. The **M232** adds serial communications and alarms (optional output) to the **M212**.

Software:

- **QDSP Standard** for setting and monitoring software

6.3 Measurements

The **M2X2** family is therefore ideally suited to applications where continuous monitoring of a single or three-phase system is required:

- **M212**: local indication for ac switchboard power measurements, energy metering into a remote energy management system using pulsed outputs.
- **M232**: local and remote indication for ac switchboard power measurements, energy metering into a remote energy management system via pulsed outputs or communications.

TABLE 7-1 has a summary of the measurements available. The **M2x2** can be user configured for either single or three phase connection.

TABLE 7-1 : MEASUREMENTS	M212	M232
V, I, P, Q, S, PF, PA, F, φ	●	●
Energy kWh class 1	●	●
Maximum demand	●	●
THD	●	●

6.4 Hardware features

The **M2X2** family has a number of hardware features that are designed to make the installation, commissioning and use of the meters as simple as possible, see TABLE 7-2.

It has a large 128 x 64 pixel Liquid Crystal Display (LCD) that can display information in a number of different font sizes and is backlit for use in conditions with a low light level. The menu is driven locally by a 5 key function pad on the front of the meter and the **M2x2** family has the ability to customise the display functions to enable to user to retrieve information as quickly as possible.

The **M2x2** has LED indicators defining energy flow and active alarms (M232 only).

The **M2x2** has a Universal auxiliary supply and an auto ranging current and voltage (option) measurement inputs so that it can be used in most site conditions without the need to specify this information at the order stage.

TABLE 7-2 : HARDWARE	M212	M232
Large backlit LCD 128 x 64	●	●
LED alarm indication	●	●
5 key menu	●	●
Autorange Volts and Current inputs (Volts optional)	●	●
Universal Power supply AC/DC	●	●
4 Energy counters	●	●

6.5 Communication and inputs/outputs

The **M232** is fitted as standard with RS232, RS485 or USB communications supporting Modbus RTU.

The **M2x2** has two rear hardware modules; module 1 is always fitted with pulse contact outputs which on the **M232** can also be used as alarm outputs if pulses are not required. Tariff inputs on module 2 are available as an option.

TABLE 7-3 : COMMUNICATIONS and I/O	M212	M232
RS232, RS485 or USB		●
Modbus RTU		●
2 energy contacts	●	●
2 tariff inputs (optional)	●	●
2 alarm contacts (using energy contacts)		●

6.6 User features

The **M2X2** family has a wide range of user features that are designed to make the installation and commissioning simple. These features are summarised in TABLE 7-4 below.

The Setup Wizard takes the user through the basic settings required to set up the **M2x2**. The benefit of the wizard is that it leads the commissioning engineer through all the basic settings required to install the **M2x2** correctly.

The **M2x2** will monitor the voltage and current polarity and when it detects that an input has been incorrectly connected it will display a warning symbol on the display. This is useful when direction is important, such as in energy applications, to ensure that the values calculated are correct.

The **M2x2** provides many different measurements that the operator can scroll through and read on the display. If the operator only wants to see a small number of measurements, they can configure the display to show up to 3 customised screens. The refresh time is programmable to enable the operator time to interpret the information on the display.

TABLE 7-4 : USER FEATURES	M212	M232
Set up Wizard	●	●
Wrong connection warning	●	●
3 Custom screens	●	●
Demonstration screens	●	●

6.7 Applications

The **M2x2** family can be used in a wide range of different applications depending on the model, the applications are summarised in TABLE 7-5 below.

TABLE 7-5 : APPLICATION	M212	M232
Power measurements	●	●
Energy Metering	●	●
Programmable alarms		●
PC software		●

Power Measurements: All the **M2x2** family provide a wide range of instantaneous measurement values; Voltage, current, Power, phase angle, power factor and frequency. These are available locally on all the **M2x2** family and remotely on the **M232**.

Energy and sub Metering: With 4 quadrant energy measurement, the **M2x2** can be used in sub metering applications where information is passed to an energy management system to monitor the performance of the ac power system. The **M2x2** can use a combination of pulsed energy contacts, tariff inputs and communications to integrate with and provide this data to the control system.

7. SYSTEM MODES

7.1 Connection mode

The connection mode of the **M2x2** is menu-configurable. The following options are available:

- 1b - single phase connection,
- 3b - three-phase, three-wire connection with balanced load,
- 4b - three-phase, four-wire connection with balanced load,
- 3u - three-phase, three-wire connection with unbalanced load
- 4u - three-phase, four-wire connection with unbalanced load.

7.1.1 Valid measurements

The following tables list the valid measurements for each connection type.

Key: ● – measured , ○ – calculated, × – not supported

	TABLE 8-1 : BASIC MEASUREMENTS	Parameter	Unit	Connection				
				1b	3b	3u	4b	4u
Phase	Voltage U_1	U1	V	●	×	×	●	●
	Voltage U_2	U2	V	×	×	×	○	●
	Voltage U_3	U3	V	×	×	×	○	●
	Average voltage U^{\sim}	U_{λ}	V	×	×	×	○	●
	Current I_1	I1	A	●	●	●	●	●
	Current I_2	I2	A	×	○	●	○	●
	Current I_3	I3	A	×	○	●	○	●
	Current I_n	I _n	A	×	○	○	○	●
	Total current I_t	I	A	●	○	○	○	●
	Average current I_a	I _{avg}	A	×	○	○	○	●
	Active power P_1	P1	W	●	×	×	●	●
	Active power P_2	P2	W	×	×	×	○	●
	Active power P_3	P3	W	×	×	×	○	●
	Total active power P_t	P	W	●	●	●	○	●
	Reactive power Q_1	Q1	var	●	×	×	●	●
	Reactive power Q_2	Q2	var	×	×	×	○	●
	Reactive power Q_3	Q3	var	×	×	×	○	●
Total reactive power Q_t	Q	var	●	●	●	○	●	

	TABLE 8-2 : BASIC MEASUREMENTS	Parameter	Unit	Connection Type				
				1b	3b	3u	4b	4u
Phase	Apparent power S_1	S1	VA	●	×	×	●	●
	Apparent power S_2	S2	VA	×	×	×	○	●
	Apparent power S_3	S3	VA	×	×	×	○	●
	Total apparent power S_t	S	VA	●	●	●	○	●
	Power factor PF_1	PF1/ePF1		●	×	×	●	●
	Power factor PF_2	PF2/ePF2		×	×	×	○	●
	Power factor PF_3	PF3/ePF3		×	×	×	○	●
	Total power factor PF_{\sim}	PF/ePF		●	●	●	○	●
	Power angle φ_1	φ_1	°	●	×	×	●	●
	Power angle φ_2	φ_2	°	×	×	×	○	●
	Power angle φ_3	φ_3	°	×	×	×	○	●
	Total power angle φ_{\sim}	φ	°	●	●	●	○	●
	THD of phase voltage U_{f1}	U1%	%THD	●	×	×	●	●
	THD of phase voltage U_{f2}	U2%	%THD	×	×	×	○	●
	THD of phase voltage U_{f3}	U3%	%THD	×	×	×	○	●
	THD of phase current I_1	I1%	%THD	●	●	●	●	●
THD of phase current I_2	I2%	%THD	×	○	●	○	●	
THD of phase current I_3	I3%	%THD	×	○	●	○	●	
Phase-to-phase	Phase-to-phase voltage U_{12}	U12	V	×	●	●	○	●
	Phase-to-phase voltage U_{23}	U23	V	×	●	●	○	●
	Phase-to-phase voltage U_{31}	U31	V	×	●	●	○	●
	Average phase-to-phase voltage (U_{ff})	U_{Δ}	V	×	●	●	○	●
	Phase-to-phase angle φ_{12}	φ_{12}	°	×	×	×	○	●
	Phase-to-phase angle φ_{23}	φ_{23}	°	×	×	×	○	●
	Phase-to-phase angle φ_{31}	φ_{31}	°	×	×	×	○	●
	THD of phase-to-phase voltage $THD_{U_{12}}$	U12%	%THD	×	●	●	○	●
	THD of phase-to-phase voltage $THD_{U_{23}}$	U23%	%THD	×	●	●	○	●
THD of phase-to-phase voltage $THD_{U_{31}}$	U31%	%THD	×	●	●	○	●	
Energy	Counters 1-4	E1, E2, E3, E4	Wh Vah varh	●	●	●	●	●
	Active tariff	Atar		●	●	●	●	●

	TABLE 8-2 : BASIC MEASUREMENTS	Parameter	Unit	Connection Type				
				1b	3b	3u	4b	4u
Max. values MD	MD current I ₁	I1	A	●	●	●	●	●
	MD current I ₂	I2	A	×	○	●	○	●
	MD current I ₃	I3	A	×	○	●	○	●
	MD active power P (positive)	P+	W	●	●	●	●	●
	MD active power P (negative)	P-	W	●	●	●	●	●
	MD reactive power Q-L	Q ⌚	var	●	●	●	●	●
	MD reactive power Q-C	Q ⌚	var	●	●	●	●	●
	MD apparent power S	S	VA	●	●	●	●	●

Key ● –measured, ○ – calculated, × – not supported

NOTE: For 3b and 3u connection mode, only phase-to-phase voltages are measured. Because of that, factor $\sqrt{3}$ is applied to calculation of quality considering nominal phase voltage.
For 4u connection mode measurements support is same as for 1b.

7.2 Power mode

The power mode is used for the signing of power measurements. The user cannot set the **M2x2** power mode. It is defined as follows:

- When displaying active power, a positive sign indicates export power (a consumer) whilst a negative sign indicates import power (a generator).
- When displaying reactive power, a coil symbol indicates an inductive load (a consumer) whilst a capacitor symbol indicates a capacitive load (a generator).

7.3 Operating energy quadrants

The operating energy quadrants are used to determine which types of energy are added to the energy counters. The user may modify the operating energy quadrants via the remote communications interface or by using the front menu and buttons.

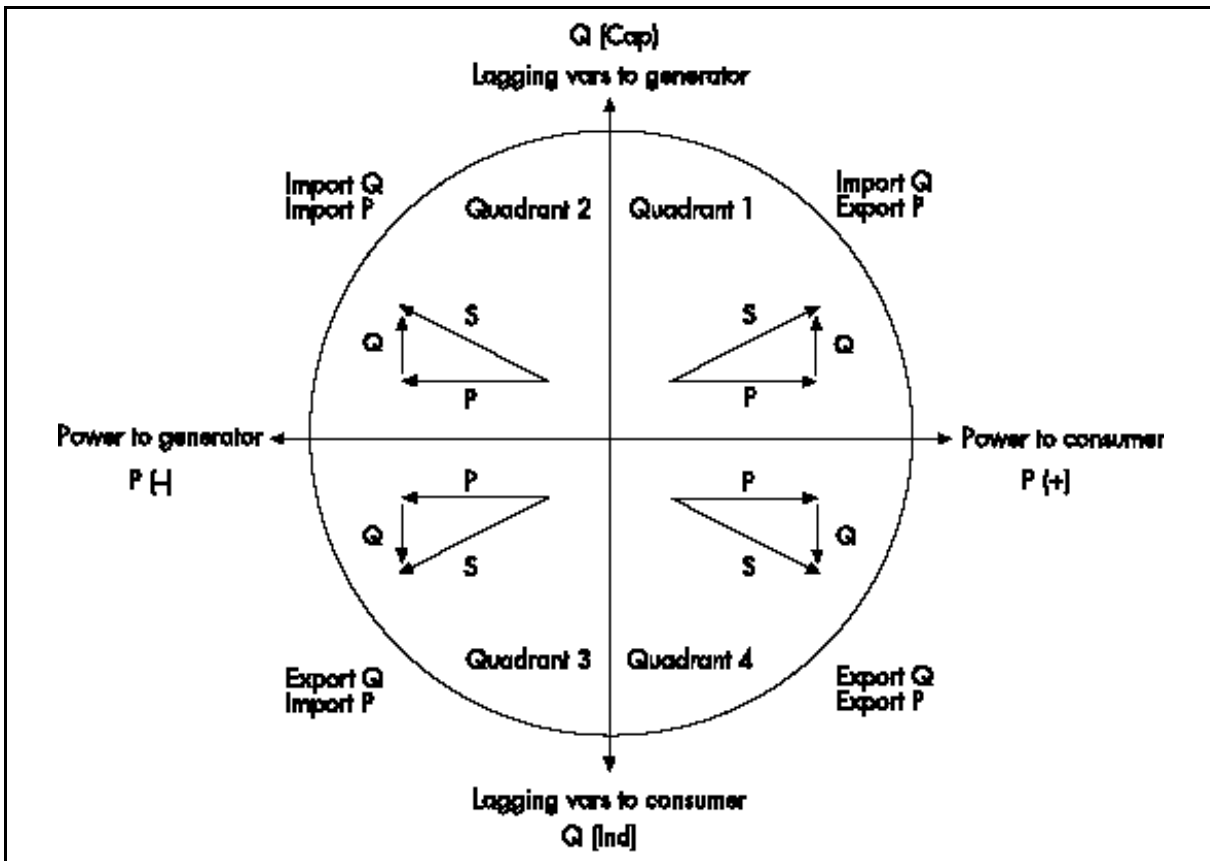

FIGURE 8-1 : POWER FLOW

8. INSTRUMENTATION

8.1 Measurements

With the increase in harmonics present in today's power systems, due to the increased use of electronic loads such as computers, variable frequency drives, etc. it is important, when accurate monitoring of electrical parameters is required, to use a measuring technique that allows for their presence. Conventional measurement methods, that use a mean sensing technique, respond to the mean or average of the input waveform. This is only accurate when the input waveform approaches a pure sinusoid.

The **M2x2** uses a true RMS (root-mean-square) measurement technique that provides accurate measurement with harmonics present up to the 63rd. The **M2x2** reads 128 samples per cycle and the true RMS measurement is obtained using these sampled values.

The **M2x2** display can display the measured values in a number of preset display views or the user can customise the display. An example is shown in figure 9.1 below.

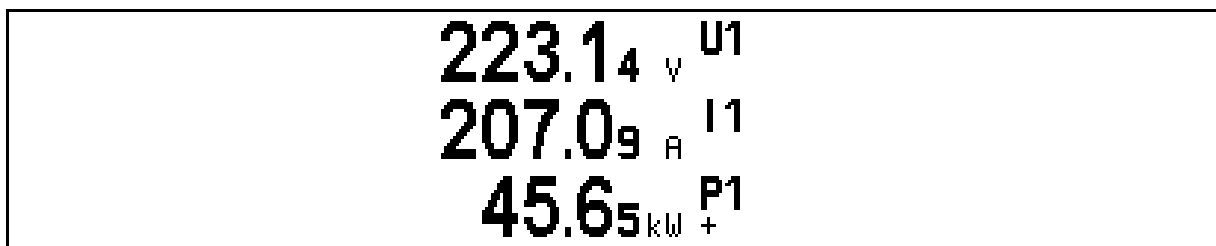

FIGURE 9-1 : PRESET DISPLAY SHOWING VOLTAGE, CURRENT AND POWER IN PHASE 1

8.2 Glossary

The following terms and symbols are used:

TABLE 9-1 : SYMBOLS	
M_v	Sample factor
M_P	Averaging interval
U_f	Phase voltage (U_1 , U_2 or U_3)
U_{ff}	Phase-to-phase voltage (U_{12} , U_{23} or U_{31})
N	Total number of samples in a period
n	Sample number ($0 \leq n \leq N$)
x, y	Phase number (1, 2 or 3)
i_n	Current sample n
U_{fn}	Phase voltage sample n
U_{ffn}	Phase-to-phase voltage sample n
φ_f	Power angle between current and phase voltage f (φ_1 , φ_2 or φ_3)
U_u	Voltage unbalance
U_c	Agreed supply voltage

TABLE 9-2 : GLOSSARY	
Term	Explanation
RMS	Root Mean Square value
Flash	Type of a memory module that keeps its content in case of power supply failure
MODBUS	Industrial protocol for data transmission
QDSP	Software for iSTAT family
AC	Alternating voltage
PA	Power angle (angle between current and voltage)
PF	Power factor
THD	Total harmonic distortion
MD	Measurement of average values in time interval
Harmonic voltage – harmonic	Sine voltage with frequency equal to integer multiple of basic frequency
Hand-over place	Connection spot of consumer installation in public network
Sample factor (M_v)	Defines a number of periods for measuring calculation on the basis of measured frequency
Averaging interval (M_p)	Defines frequency of refreshing displayed measurements on the basis of a Sample factor

8.3 Supported Measurements

The measurements that the **M2x2** family supports are shown in the following table.

TABLE 9-3 : BASIC MEASUREMENTS	
Phase	Voltage U_1, U_2, U_3 in U_{\sim}
	Current I_1, I_2, I_3, I_n, I_t in I_a
	Active power $P_1, P_2, P_3,$ and P_t
	Reactive power $Q_1, Q_2, Q_3,$ and Q_t
	Apparent power $S_1, S_2, S_3,$ and S_t
	Power factor PF_1, PF_2, PF_3 and PF_{\sim}
	Power angle $\varphi_1, \varphi_2, \varphi_3$ and φ_{\sim}
	THD of phase voltage U_{f1}, U_{f2} and U_{f3}
	THD of current I_1, I_2 and I_3
Phase-to-phase	Phase-to-phase voltage U_{12}, U_{23}, U_{31}
	Average phase-to-phase voltage U_{ff}
	Phase-to-phase angle $\varphi_{12}, \varphi_{23}, \varphi_{31}$
	THD of phase-to-phase voltage
Energy	Counter 1
	Counter 2
	Counter 3
	Counter 4
	Total
	Active tariff
Maximal values MD	Phase current I_1
	Phase current I_2
	Phase current I_3
	Active power P (Positive)
	Active power P (Negative)
	Reactive power Q - L
	Reactive power Q - C
	Apparent power S
	Frequency f
	Internal temperature

The equations defining the calculated values are detailed in Appendix B

8.3.1 Voltage

All versions of the **M2x2** except for the 3-phase 3-wire versions, measure the true RMS value of the phase voltages (U_a , U_b , U_c) connected to the unit. The three line-to-line voltages (U_{ab} , U_{bc} , U_{ca}), then the average phase voltage (U) and average line voltage (U_{Δ}) are calculated from these measured parameters. For 3-phase 3-wire balanced systems, the **M2x2** creates a virtual neutral internally.

The 3-phase 3-wire versions of the **M2x2** measure the true RMS value of the phase to phase voltage.

All voltage measurements are available via communication and on the LCD display.

8.3.2 Current

The **M2x2** measures the true RMS value of the phase currents (I_a , I_b , I_c) connected to the unit. The neutral current (I_n), then the average of all phase currents and the sum of all phase currents (I_t) are calculated from the three phase currents.

All current measurements are available via communication and on the LCD display.

8.3.3 Frequency

The system frequency is calculated from the time period of the measured voltage and can be viewed from both the **M2x2** display and the remote communications link.

8.3.4 Harmonics (THD)

The percentage total harmonic distortion (%THD) value is the ratio of the sum of the powers of the harmonic frequencies (to 32nd) above the fundamental frequency to the power of the fundamental frequency. This sum of the powers is a geometric total, formed by taking the square root of the sum of the squares of the amplitude of each of the harmonics.

The **M2x2** provides %THD values for each phase current, each phase voltage, and for the line voltages.

8.3.5 Power

The **M2x2** provides accurate measurement of active (P_a , P_b , P_c , P_t), reactive (Q_a , Q_b , Q_c , Q_t) and apparent power (S_a , S_b , S_c , S_t). For a four-wire system the powers are calculated both for each phase separately and as a total. For a three-wire system only total power values are measured.

All the available power parameters can be viewed using either the LCD display or via the remote communications link.

8.3.6 Power factor

The power factor is calculated as a quotient of active and apparent power for each phase separately ($\cos\phi_a$, $\cos\phi_b$, $\cos\phi_c$) and as a total ($\cos\phi_t$). A positive sign and a coil symbol denotes an inductive load (a consumer) whilst a negative sign and a capacitor symbol defines a capacitive load (a generator). For correct display of PF via application of the alarm, ePF (extended power factor) is applied. It illustrates power factor with one value as described in the table below. For a display on LCD both of them have equal display function: between -1 and 1 with the icon for inductive or capacitive load.

Load	C	→		←	L
Angle [°]	-180	-90	0	+90	+180 (179.99)
PF	-1	0	1	0	-1

All available power factor parameters can be read from the LCD display or via the remote communications link.

8.3.7 Energy

Four counters are available so that energy in each of the four quadrants can be measured. The configuration of the four counters can be adapted to the customer's needs via the front menu or via the remote communications link.

All four energy measurements may be viewed using either the **M2x2** display or the remote communications link.

8.3.8 Maximum demands (MDs)

The **M2x2** provides maximum demand values using average Thermal Demand.

The **M2x2** stores the maximum demand value since last reset. The unit also displays the present or 'dynamic' maximum demand.

8.3.9 Thermal Average demands

Thermal demand will provide an exponential thermal characteristic, based on the bimetal element principal. Maximum demand and the time of its occurrence are stored in the unit.

Maximal values and time of their occurrence are stored in **M2x2**. A time constant (t. c.) can be set from 1 to 255 minutes and is 6-time thermal time constant (t.c. = 6 * thermal time constant).

Example:

Mode: Thermal function

Time constant: 8 min.

Current MD and maximal MD: Reset at 0 min.

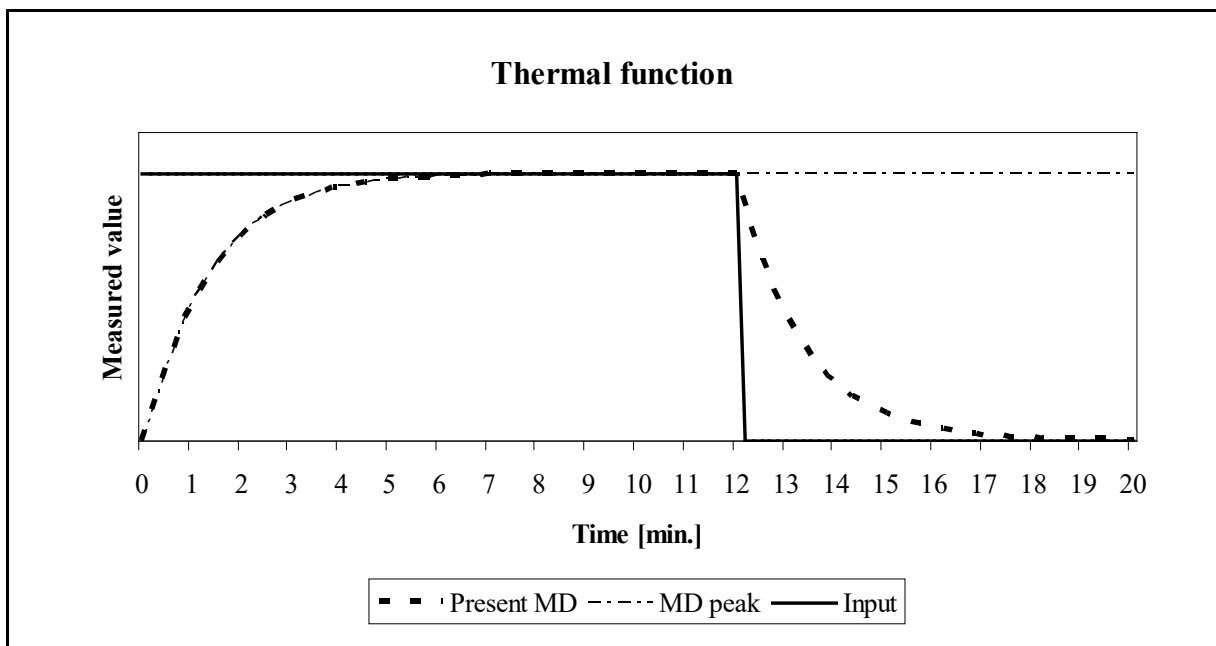

9. HARDWARE

The connections to the **M2x2** Measurement Centre are made on the rear as shown in Figure 10-1

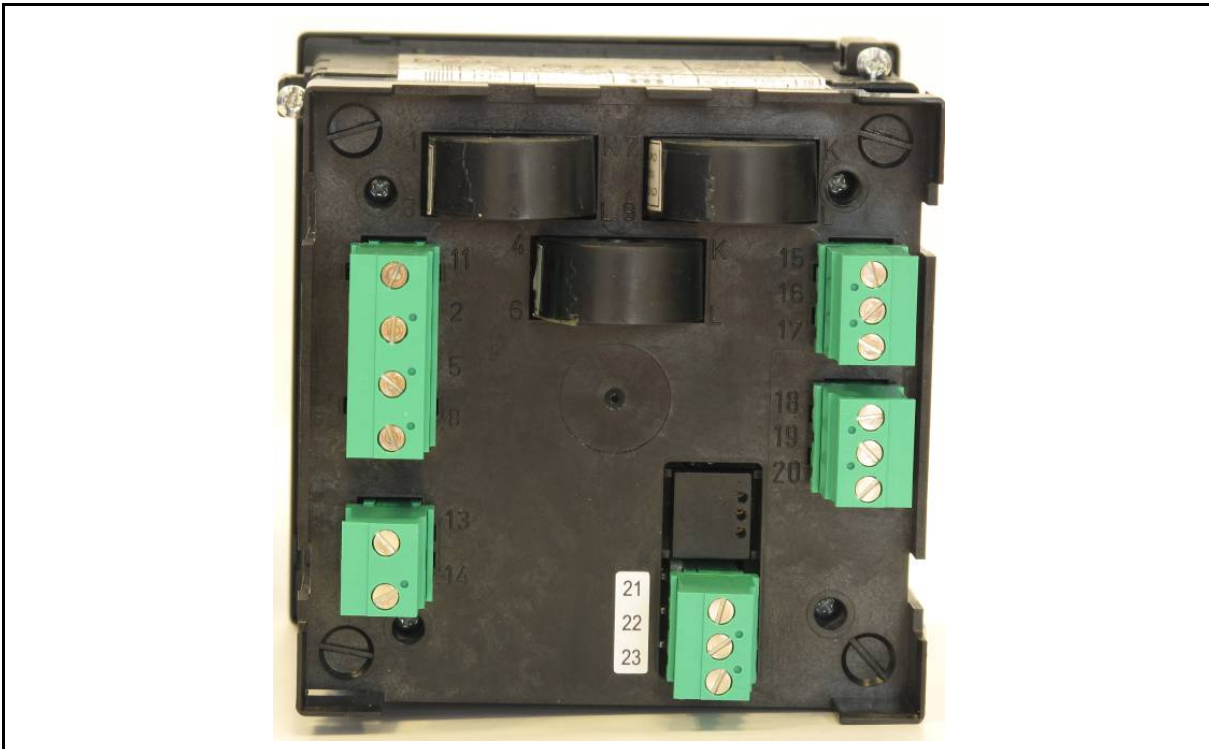

FIGURE 10-1 : M232 REAR CASE VIEW

9.1 Connections

Voltage inputs of the **M2x2** can be connected directly to a low-voltage network or via a voltage transformer to a high-voltage network.

Current inputs of **M2x2** are achieved by feeding the current carrying cable through a hole in the current transformers. Connection to the network is performed via a corresponding current transformer.

The **M2x2** has an auto-ranging current input with a nominal 5A and either a fixed voltage input at nominally 63.5V or an auto-ranging voltage input (option) at a nominal 500V.

Since the **M2x2** also has a fully configurable connection mode the default information is shown as 4u (three phase, 4 wire unbalanced) and the default connection diagram also shows this connection.

Connection diagrams for the different network structures are shown in Section 16.

9.2 Communications

The **M232** can be supplied with RS232, RS485 or USB electrically isolated communications that must be specified at time of ordering. The **M232** supports MODBUS RTU, detailed in Appendix A, allowing remote viewing of measurements and viewing and setting of system parameters.

The connection of RS232 communications has a maximum cable length of 15 metres.

Two-wire RS485 communications enables simultaneous connection to a maximum of 32 communicating devices, over distances of 1000m. For long cable distances a terminating resistor (120 ohm) may have to be connected between the 2 wires at the extreme ends of the cable network.

Connection information is shown in table 10-1.

		Position	Data direction	Description
RS232		21	MC input pin	Data reception (Rx)
		22	-	Grounding (\perp)
		23	MC output pin	Data transmission (Tx)
RS485		21	To/From MC	A
		22	-	Do not connect!
		23	To/From MC	B
USB			To/From MC	USB B

TABLE 10-1 : RS232, RS485, AND USB CONNECTIONS

9.3 Inputs and Outputs

The **M2x2** has two rear hardware modules; module 1 is always fitted with pulse contact outputs which on the **M232** can also be used as alarm outputs if pulses are not required. Tariff inputs are available as an option on module 2.

	M212	M232
2 energy contacts	●	●
2 tariff inputs (optional)	●	●
2 alarm contacts (using energy contacts)		●

TABLE 10-2 : INPUTS AND OUTPUTS

I/O hardware module 1 uses terminals 15/16/17 and module 2 uses 18/19/20.

9.3.1 Energy Pulse Outputs

The 2 energy pulsed outputs are always fitted on the **M2x2** and can be used for external monitoring of energy consumption. The energy measuring via the pulsed outputs corresponds to the basic energy measurement on the **M2x2** display. The pulsed outputs' energy measurement can be adapted to the customers' needs via the remote communications link.

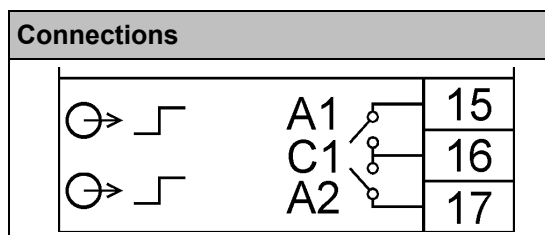

TABLE 10-3: DUAL ENERGY CONTACTS

The hardware module has three terminals (see 10-3), the energy contacts share a common connection but each contact can be individually set.

9.3.2 Tariff (inputs)

The 2 tariff inputs can be used to set the currently active tariff. They are an option module that must be defined at the time of ordering.

The hardware module has three terminals (see table 10-4), the tariff voltage inputs are 110 or 230Vac \pm 20% (order option) and share a common connection but each input can be individually set. When both inputs on the module are used, the **M2x2** will provide a maximum of 4 tariffs.

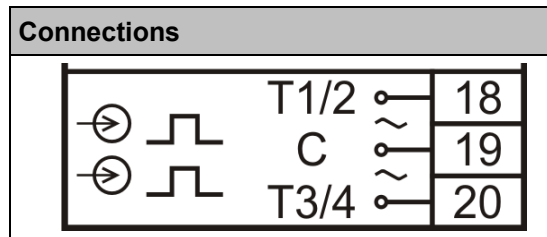

TABLE 10-4: TARIFF INPUTS

9.3.3 Alarm outputs

The Energy pulse outputs on the **M232** can be optionally programmed to output alarm conditions if the pulse outputs are not required. The alarms can be set using QDSP via the remote communications link.

The hardware port has three terminals (see table 10-5), the alarm contacts will share a common connection but each contact can be individually set.

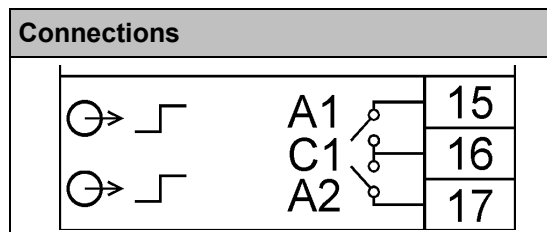

TABLE 10-5: ALARM CONTACTS

9.4 Auxiliary Supply

The **M2x2** family is supplied with a Universal AC/DC auxiliary power supply.

Parameter	Universal Auxiliary Voltage
AC Nominal Voltage	48 – 230V ac
Frequency	40 – 65Hz
DC Nominal Voltage	20 – 300Vdc
Burden	< 5 VA

TABLE 10-6: AUXILIARY SUPPLY

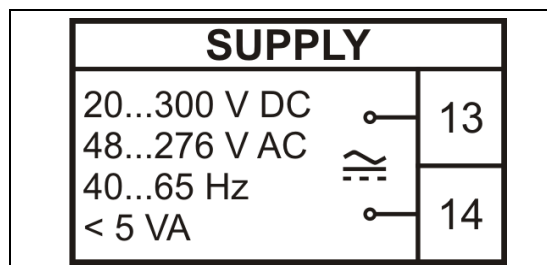

TABLE 10-7: POWER SUPPLY CONTACTS

10. USER INTERFACE MENU STRUCTURE

10.1 Menu introduction

The settings, measurements and functions of the **M2x2** can be accessed from either the front panel or the remote communications link (**M232** only). The menu structure of the **M2x2** is navigated using the five keys on the front panel as shown in figure 11-1 below:



FIGURE 11-1 : M232 FRONT VIEW

Throughout this section the following symbols are used in the diagrams to relate to pressing the corresponding key on the front panel.

Key	Left	Right	Down	Up	Enter
Symbol	◀	▶	▼	▲	OK

Throughout this section the following symbols are used in the diagrams to relate to information displayed on the LCD

Key	Password locked	Wrong connection warning	Navigation keys	Auxiliary supply too low
Symbol				

The **M2x2** is supplied with the Level 1 password set to AAAA. Level 2 password has not been set. AAAA passwords offer no level of protection; all measurements and settings can be modified. The passwords must be changed from AAAA to activate password level protection.

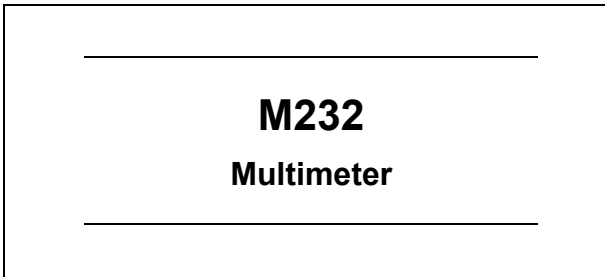

Figure 11-2a
initial power up display

When the **M2x2** is first connected to the power system, the user is greeted with the message shown in Figure 11-2a above. This information will be displayed for a few seconds before the main menu is shown, initially as shown by Figure 11-2b below, but otherwise displays the last menu screen used.

The display is divided into 3 parts separated by two horizontal lines; Top, Main and Bottom. The Top display tells the operator the name of the main display, the bottom display provides display specific information and the main display shows the functions for that main display screen.

The bottom display alternates between the device temperature and web site address.

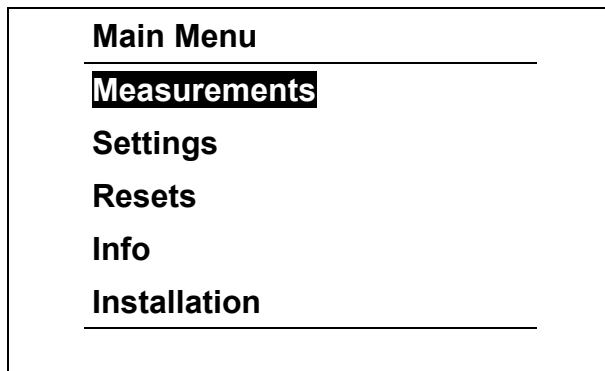

Figure 11-2b
Main Menu display

Bottom display

When first switched on or during operation, the main menu of the **M2x2** can be accessed to pressing the <LEFT key until the menu is displayed, this is shown in Figure 11-2b and gives the user 5 options; Measurements, Settings, Resets, Info (Information) and Installation. Navigation is done by pressing the DOWN▼ or UP▲ keys and then pressing the OK key to make a selection. The menu cycles round from Installation back to Measurements.

10.2 Measurement Navigation

Figure 11-3 illustrates the **measurement** menu structure. The user can browse through the available menus using the direction keys, by pressing the DOWN▼ or UP▲ keys and then pressing the **OK** key to make a selection. The ◀LEFT key is pressed to return to the **Main Menu**.

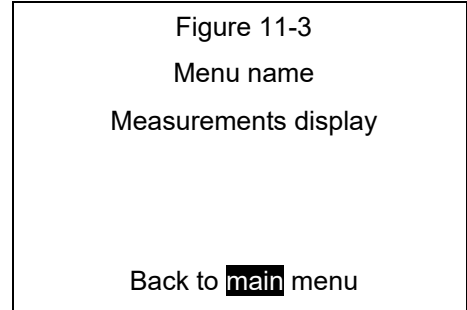
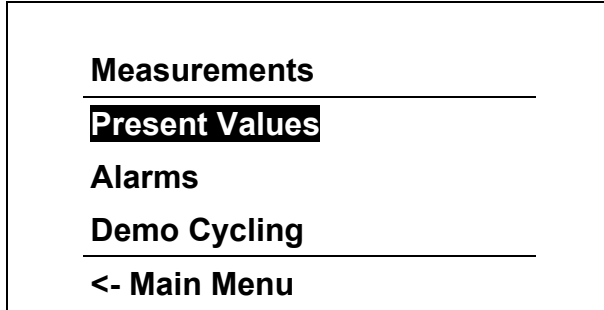

Figure 11-4 illustrates the **present value** menu structure. The user can browse through the available menus using the direction keys, by pressing the DOWN▼ or UP▲ keys and then pressing the **OK** key to make a selection. The ◀LEFT key is pressed to return to the **Measurement Menu**.

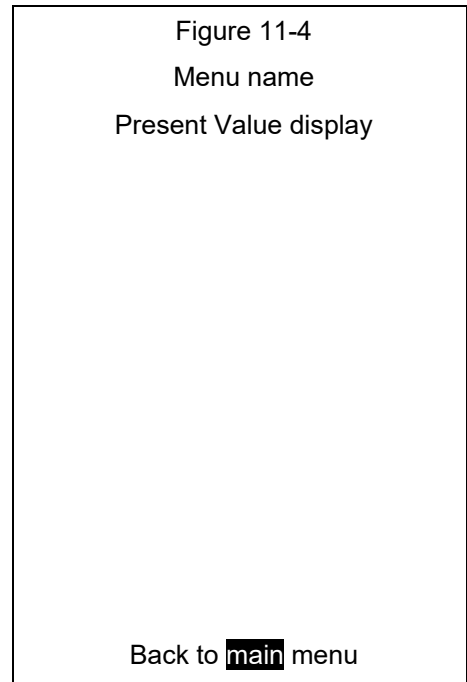
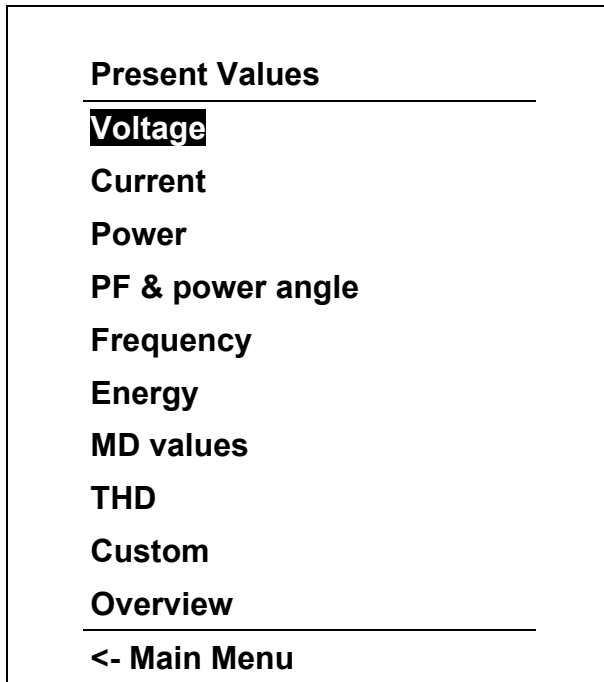

table 11-1 illustrates the **Present Values Menu** information structure. The user can browse through all the available menus using the direction keys. Pressing the **OK** key returns to the **Present Values Menu**

	Information	◀Left									Right▶
▲	Voltage		Phase Voltage	Line Voltage							
	Current	Average Current	Phase Current								
	Power	W, VA and VAR total	W per phase	VAr per Phase	VA per phase						
	PF and power angle	PF total Power angle total	PF per Phase	Power angle per Phase							
	Frequency	Frequency									
	Energy	Counters 1 & 2	Counters 3 & 4	Counter 1 history	Counter2 history	Counter3 history	Counter4 history				
	MD values	Watts+	Watts -	var	var	VA	Iphase1	Iphase2	Iphase3		
	THD	Phase Current	Phase Voltage	Line Voltage							
	Custom	User defined 1	User defined 2	User defined 3							
▼	Overview	Voltage current, Watts and VARs	Voltage current, Watts and VARs	Voltage current, Watts and VARs							

TABLE 11-1 : **PRESENT VALUES MENU** INFORMATION STRUCTURE

10.3 Settings Navigation

Figure 11-5 illustrates the **settings** menu structure. The user can browse through the available menus using the direction keys, by pressing the DOWN▼ or UP▲ keys and then pressing the **OK** key to make a selection. The ◀LEFT key is pressed to return to the **Main Menu**.

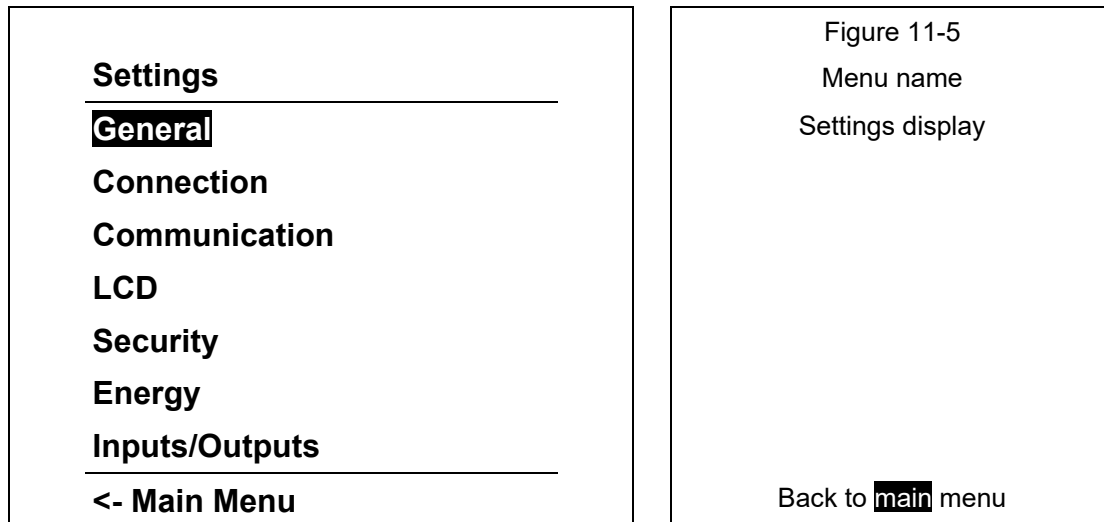

table 11-2 illustrates the **Settings Menu** information structure. The user can browse through all the available menus using the direction keys. When the settings section required is highlighted press **OK** to access the individual settings. Pressing the **◀LEFT** returns to the **Settings Menu**.

	▲						▼
▲	General	Connection	Communication	LCD	Security	Energy	Inputs/ Outputs
	Language	Connection mode	Device address	Contrast	Password level 1	Active tariff	I/O 1
	Temperature unit	VT primary	Baud rate	Backlight	Password level 2	Common en. exponent	I/O 2
	MD time constant	VT secondary	Parity	Backlight time off	Password lock time	LED Counter	I/O 3
	Average interval	CT primary	Stop bits	Demo cycling period	Lock instrument	LED No. of pulses	I/O 4
		CT secondary		Custom screen 1	Unlock instrument	LED Pulse length	
				Custom screen2			
▼				Custom screen3			

TABLE 11-2 : **SETTINGS MENU** INFORMATION STRUCTURE.

10.4 Resets Navigation

Figure 11-6 illustrates the **resets menu** structure. The user can browse through the available menus using the direction keys, by pressing the DOWN▼ or UP▲ keys and then pressing the OK key to make a selection. The ◀LEFT key is pressed to return to the **Main Menu**

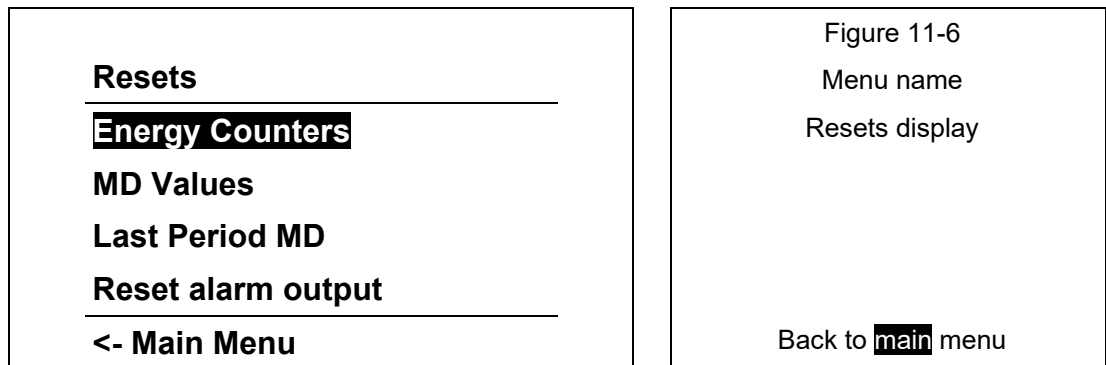

table 11-3 illustrates the **Resets Menu** information structure. The user can browse through all the available menus using the direction keys. . When the settings section required is highlighted press OK to access the individual settings. Pressing the ◀LEFT key returns to the **Resets Menu**.

	▲			▼
▲	Energy counters	MD values	Last period MD	Reset Alarm output
	All energy counters	No/Yes	No/Yes	No/Yes
	Energy counter E1			
	Energy counter E2			
	Energy counter E3			
▼	Energy counter E4			

TABLE 11-3 : **RESETS MENU** INFORMATION STRUCTURE

10.5 Info Navigation

Figure 11-7 illustrates the **Product Identify** display; this is also the default display during powerup. This will not refresh back to the main menu so the user has to press the ◀ LEFT key to get back to the **Main Menu**.

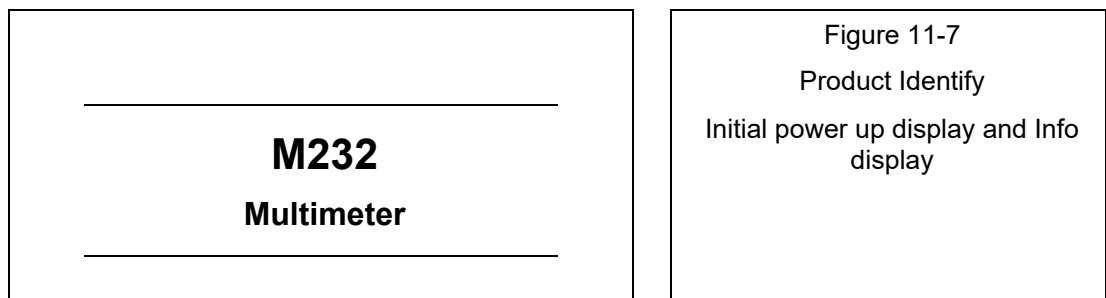
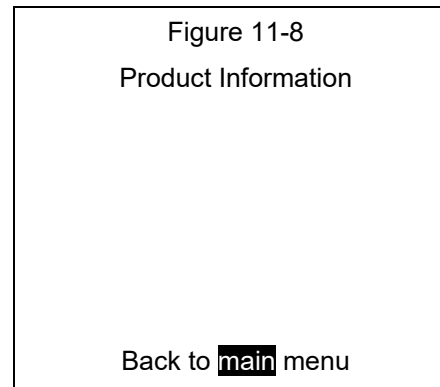
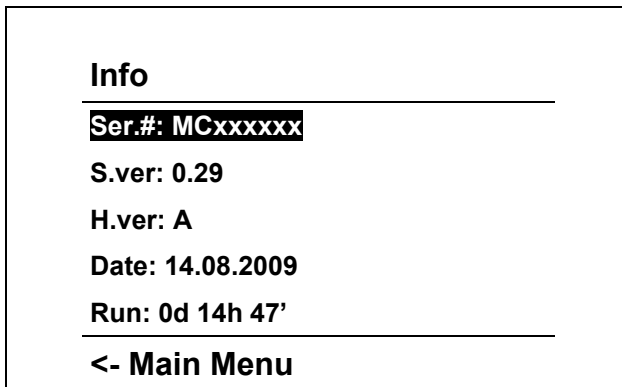

Figure 11-8 illustrates the **Product Information** display. This is viewed by pressing either pressing the ▼DOWN or ▲ UP keys;. Pressing the ◀ LEFT key to takes the user back to the **Main Menu**.



The information shown on the **Product Information** display is:

Ser.#: MCxxxxxx this is **M2x2** serial number.

S.ver: 0.29: this is the software version loaded in the **M2x2**

H.ver: A this is the hardware version of the **M2x2**

Date: 14.08.2009: this is the date that the **M2x2** was calibrated

Run: 0d 14h 47': this is time that the **M2x2** has been operating since calibration

10.6 Installation Navigation

Figure 11-9 illustrates the **Installation** menu structure. The user presses **OK** key to make a selection. The **<LEFT** key is pressed to return to the **Main Menu**

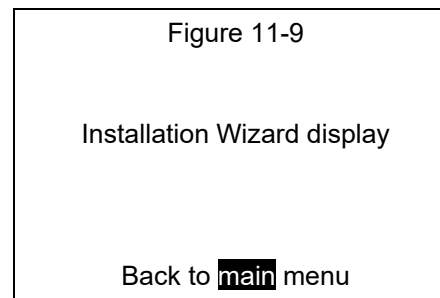
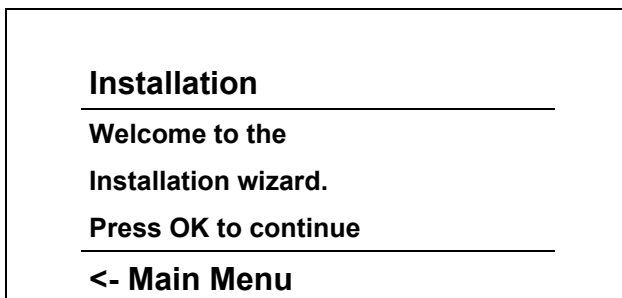

The Installation Wizard is described in section 12.1

10.7 Default settings

The **M2x2** is supplied with the following default settings. Changes to these settings can be made on the front menu or via remote communications. It is recommended that the setup wizard is used to enable basic configuration.

Language	English
Mode, CT and VT	1b, not set
Password	None set (L1 = AAAA)
Counters and registers	Set to zero
Communication	19200 bps, address 33, parity none, stop bit 2

11. HARDWARE FUNCTIONS

11.1 Installation Wizard

The Installation Wizard is designed to take the user through the minimum functions necessary to install the **M2x2**. By pressing the **OK** key the following functions can be set: Language: Connection Mode: VT Primary: VT Secondary: CT Primary: CT Secondary: Device Address: Baud Rate: Parity: Stop Bit.

From the Installation Wizard is located on the Main Menu. Press **OK** to activate the Wizard.

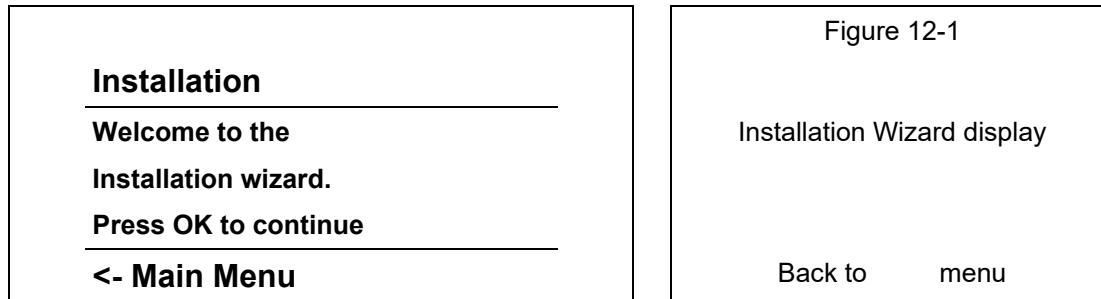

Figure 12-2 shows the **Language** setting structure. The selection is made by pressing either the **▼DOWN** or **▲UP** keys until the desired language is selected and then press **OK** key to make a selection.

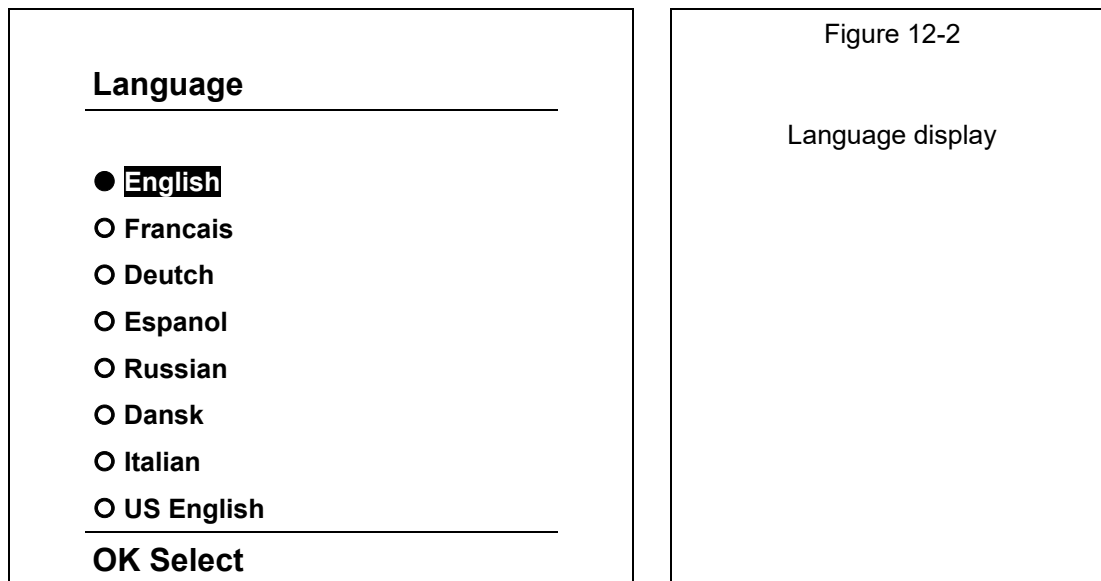

Figure 12-3 shows the **Connection Mode** setting structure. The selection is made by pressing either the **▼DOWN** or **▲UP** keys until the desired connection mode is selected and then press **OK** key to confirm. The **◀LEFT** key can be pressed to return to the **Language** setting.

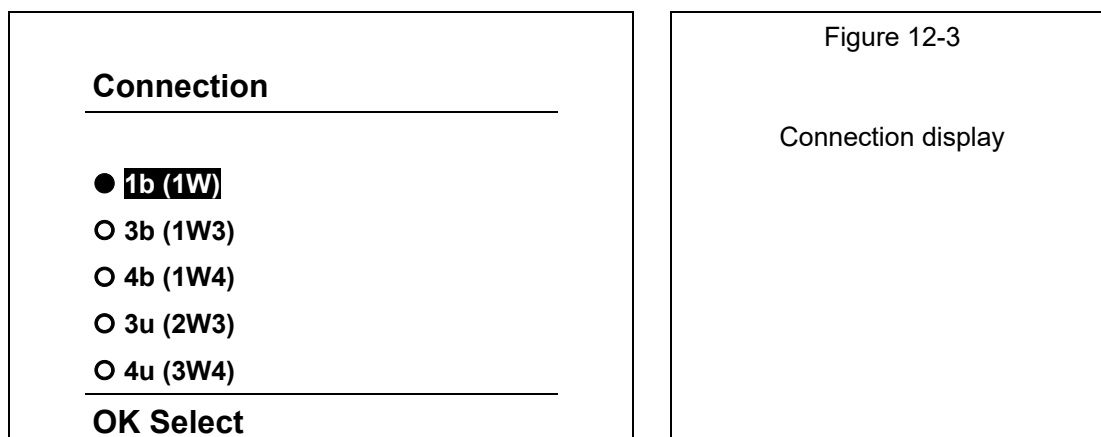

Figure 12-4 shows the **VT Primary** setting structure. An underscore shows the position of the cursor. Move along by using the **▶RIGHT** or **◀LEFT** key, changes are made by pressing

either the **▼DOWN** or **▲UP** keys until the desired setting is shown, then press **OK** key to confirm. When the cursor is under the decimal point, the decimal point location and engineering units (V, KV) can be changed. The **◀LEFT** key can be pressed to return to the **Connection Mode** setting.

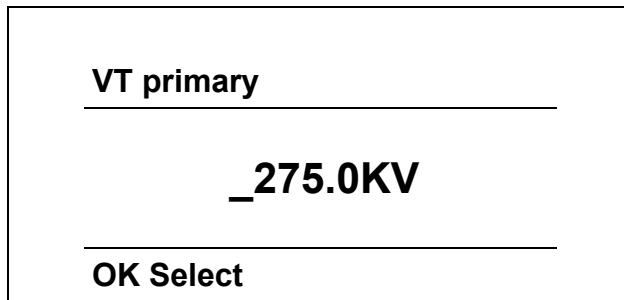

Figure 12-4
VT Primary display

Figure 12-5 shows the **VT Secondary** setting structure. An underscore shows the position of the cursor. Move along by using the **▶RIGHT** or **◀LEFT** key, changes are made by pressing either the **▼DOWN** or **▲UP** keys until the desired setting is shown, then press **OK** key to confirm. When the cursor is under the decimal point, the decimal point location and engineering units (mV, V) can be changed. The **◀LEFT** key can be pressed to return to the **VT Primary** setting.

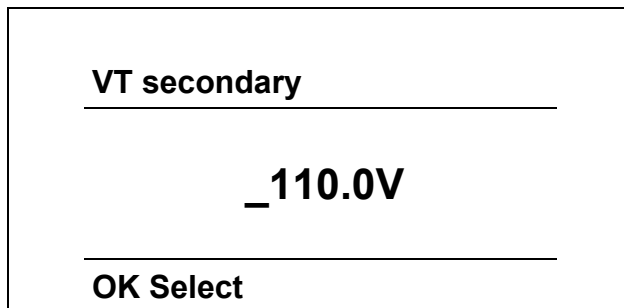

Figure 12-5
VT Secondary display

Figure 12-6 shows the **CT Primary** setting structure. An underscore shows the position of the cursor. Move along by using the **▶RIGHT** or **◀LEFT** key, changes are made by pressing either the **▼DOWN** or **▲UP** keys until the desired setting is shown, then press **OK** key to confirm. When the cursor is under the decimal point, the decimal point location and engineering units (A, KA) can be changed. The **◀LEFT** key can be pressed to return to the **VT Secondary** setting.

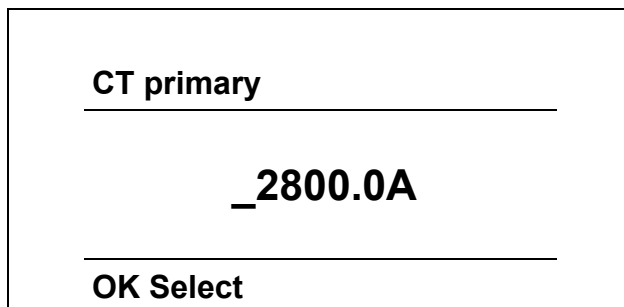

Figure 12-6
CT Primary display

Figure 12-7 shows the **CT Secondary** setting structure. An underscore shows the position of the cursor. Move along by using the **▶RIGHT** or **◀LEFT** key, changes are made by pressing either the **▼DOWN** or **▲UP** keys until the desired setting is shown, then press **OK** key to confirm. When the cursor is under the decimal point, the decimal point location and engineering units (mA, A) can be changed. The **◀LEFT** key can be pressed to return to the **CT Primary** setting.

CT secondary

_5.0A

OK Select

Figure 12-7

CT Secondary display

Figure 12-8 shows the **Device address** setting structure. An underscore shows the position of the cursor. Move along by using the **►RIGHT** or **◄LEFT** key, changes are made by pressing either the **▼DOWN** or **▲UP** keys until the desired setting is shown, then press **OK** key to confirm. The **◄LEFT** key can be pressed to return to the **CT secondary** setting. The default address is 33.

Device address

_33

OK Select

Figure 12-8

Device address display

Figure 12-9 shows the **Baud Rate** setting structure. Changes are made by pressing either the **▼DOWN** or **▲UP** keys until the desired setting is shown, then press **OK** key to confirm. The **◄LEFT** key can be pressed to return to the **Device Address** setting.

Baud rate

9600 bits/s

19200 bits/s

38400 bits/s

57600 bits/s

115200 bits/s

OK Select

Figure 12-9

Baud rate display

Figure 12-0 shows the **Parity** setting structure. Changes are made by pressing either the **▼DOWN** or **▲UP** keys until the desired setting is shown, then press **OK** key to confirm. The **◄LEFT** key can be pressed to return to the **Baud Rate** setting.

Parity

No

Old

Even

OK Select

Figure 12-10

Parity display

Figure 12-1 shows the **Stop Bit** setting structure. Changes are made by pressing either the **▼DOWN** or **▲UP** keys until the desired setting is shown, then press **OK** key to confirm. The **◀LEFT** key can be pressed to return to the **Parity** setting.

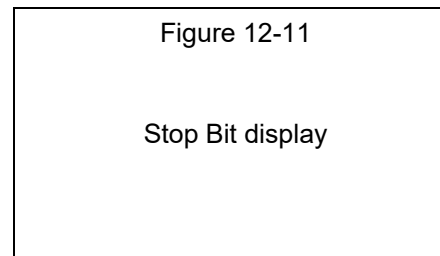
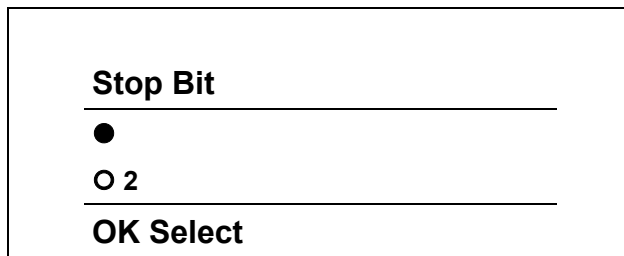
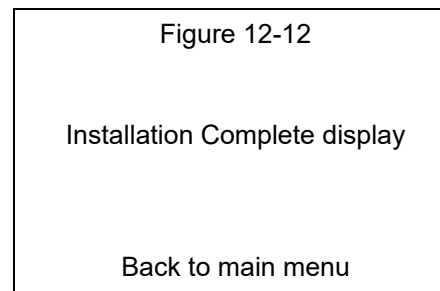
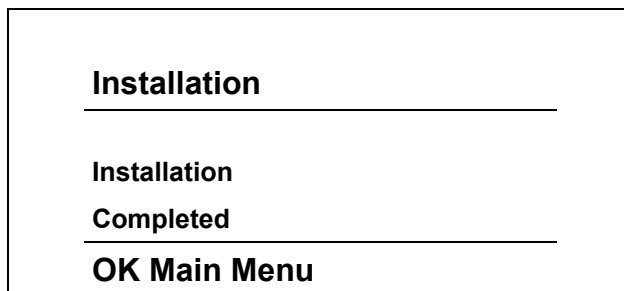

Figure 12-2 shows the **Installation Completed** display. Press **OK** key to confirm all the changes and complete the installation.



11.2 Demo Cycling

The function polls through a number of different displays that show the different features that are in the **M2x2**.

Figure 12-3 illustrates the **measurement** menu structure. The user can browse through the available menus using the direction keys, by pressing either the **DOWN▼** or **UP▲** keys and then pressing the **OK** key to select the **Demo Cycling** Menu.

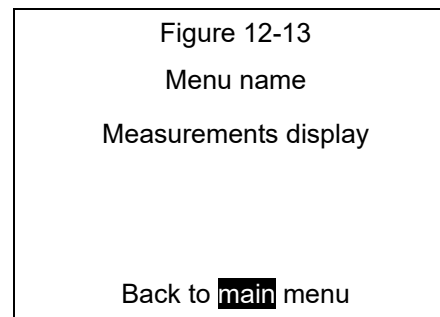
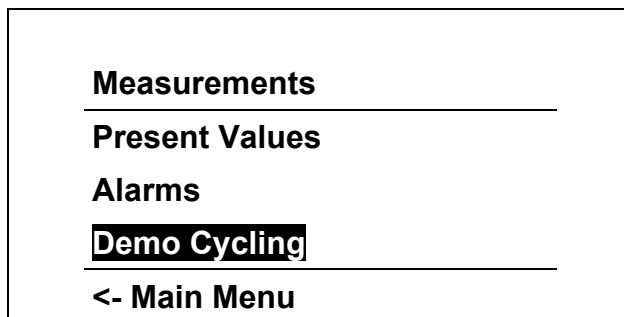
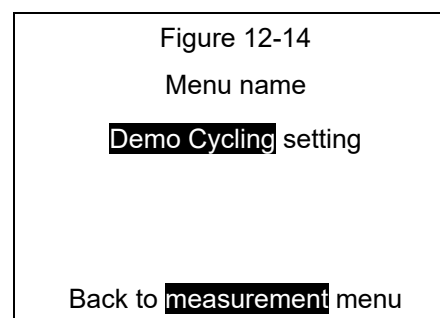
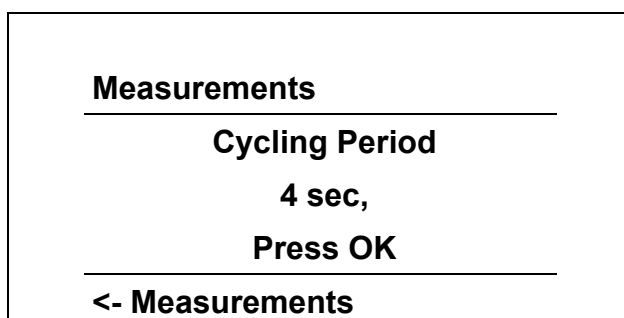

Figure 12-4 illustrates the **Demo Cycling** setting. The user presses the **OK** key to activate the **Demo Cycling** feature.



The **Demo Cycling** feature will then show various features of the **M2x2**,

- Meter identify
- Info page
- Alarm groups and status
- Voltage, CURRENT, Power and Phase angle values
- Energy values
- MD values
- THD information

The user presses the **OK** key to deactivate the **Demo Cycling** feature.

12. SETTINGS

The settings on the **M2x2** are completed using the Keypad and Display; on the **M232** they can also be done using the QDSP software over the communications link.

The Installation Wizard described in section 12.1 is designed to take the user through the minimum functions necessary to install the **M2x2**. By pressing the **OK** key the following functions can be set:

Language;

Connection Mode: VT Primary: VT Secondary: CT Primary: CT Secondary

Device Address: Baud Rate: Parity: Stop Bit

All these functions can be set individually from the settings menu. Each setting is described in the following sections.

12.1 Setting Navigation

Figure 13-1 illustrates the **Settings menu** structure. The user can browse through the available menus using the direction keys, by pressing the DOWN▼ or UP▲ keys and then pressing the **OK** key to make a selection. The ◀LEFT key is pressed to return to the **Main Menu**

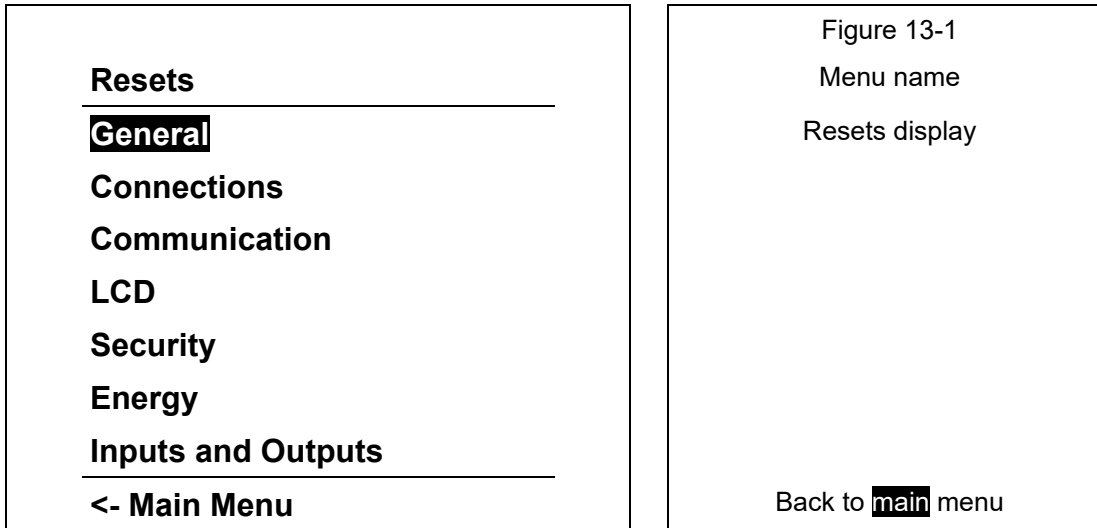

12.2 General Navigation

Figure 13-2 illustrates the **General menu** structure. The user can browse through the available menus using the direction keys, by pressing the DOWN▼ or UP▲ keys and then pressing the **OK** key to make a selection. The ◀LEFT key is pressed to return to the **Settings Menu**

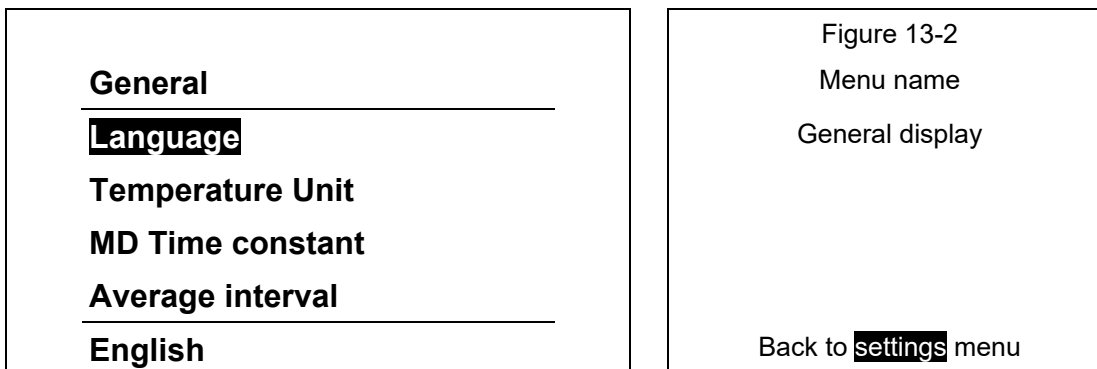

Figure 12-12 in the Installation Wizard section describes the language selection. Once selected, the language option appears in the lower menu when the cursor highlights the language option.

Figure 13-3 illustrates the **Temperature Unit** setting. The user can select either Centigrade or Fahrenheit as the unit of measure. Press the **OK** key to return back to the **General Menu**

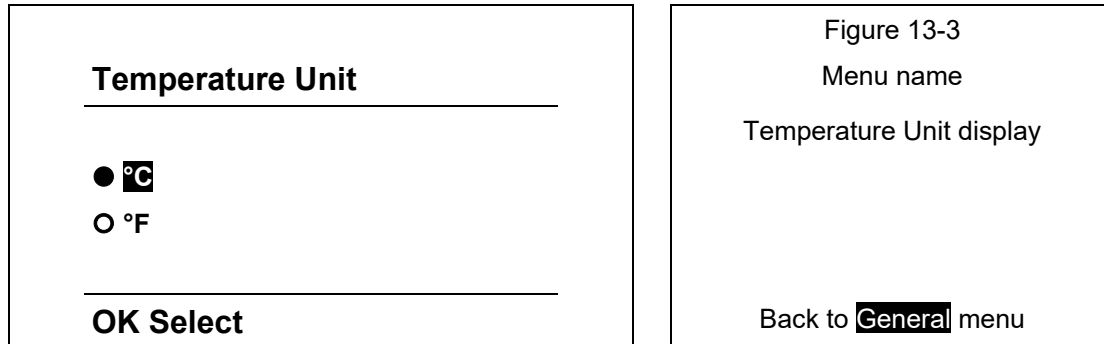

Figure 13-4 illustrates the **MD time constant** setting. The user can select a time constant setting from 1 to 255 minutes. Pressing the **DOWN**▼ or **UP**▲ keys scrolls through the options. Press the **OK** key to return back to the **General Menu**

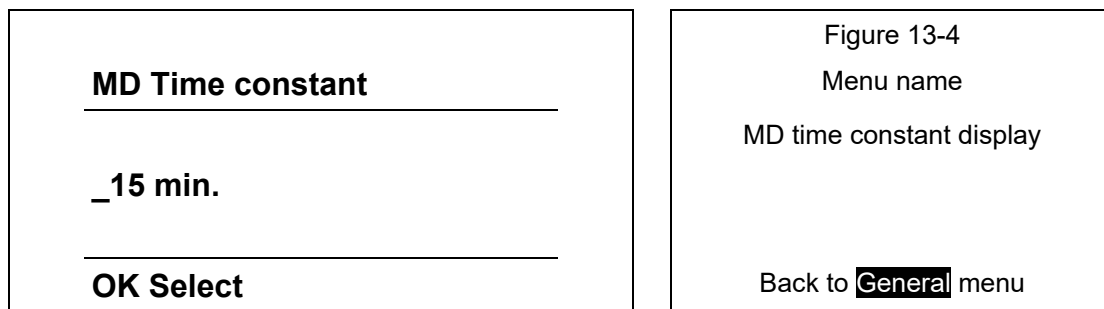
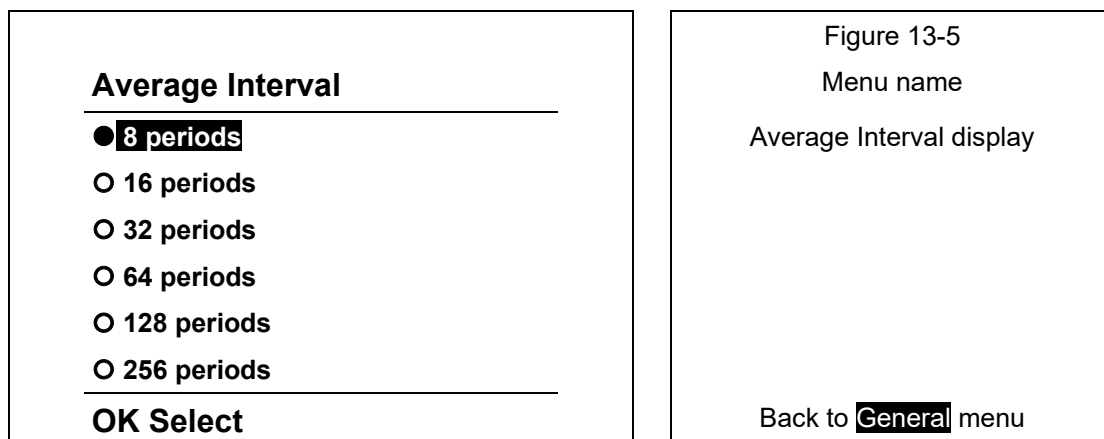
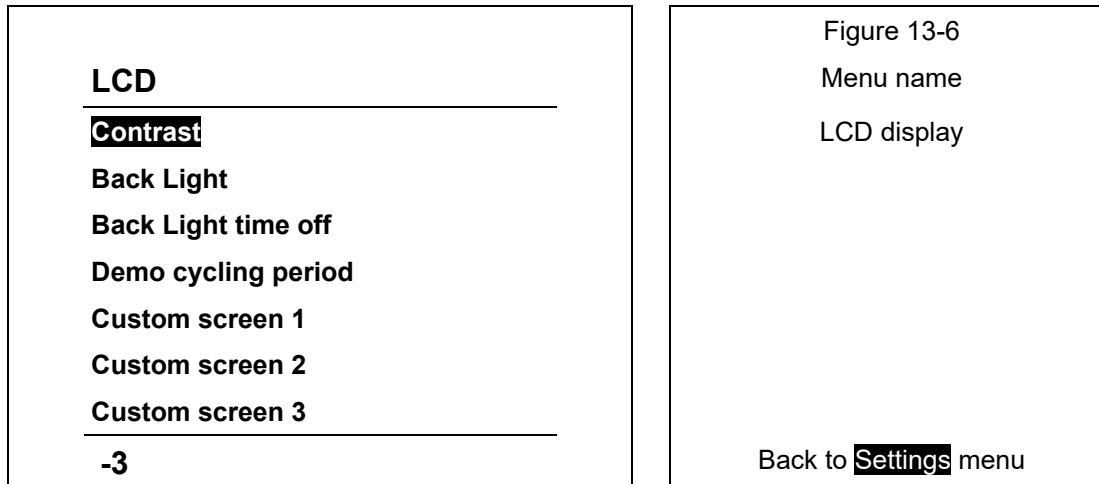

Figure 13-5 illustrates the **Average Interval** setting. The user can select from 6 different settings, from 8 periods to 256 periods. Pressing the **DOWN**▼ or **UP**▲ keys scrolls through the options. Press the **OK** key to return back to the **General Menu**



12.3 LCD Navigation

Figure 13-6 illustrates the **LCD menu** structure. The user can browse through the available settings using the direction keys, by pressing the DOWN▼ or UP▲ keys and then pressing the **OK** key to make a selection. The **LEFT** key is pressed to return to the **Settings Menu**



Contrast: this is adjusted using the DOWN▼ or UP▲ keys until the desired contrast has been reached, the scale is from -10 to +10 with -3 being the normal value. Pressing the **OK** key confirms the selection. The numeric value is shown in the lower menu when the **Contrast** setting is selected.

Back Light: this is adjusted using the DOWN▼ or UP▲ keys until the desired lighting has been reached, the scale is from 0 to +10. Pressing the **OK** key confirms the selection. The numeric value is shown in the lower menu when the **Back Light** setting is selected.

Back Light time off: this is adjusted using the DOWN▼ or UP▲ keys until the desired time off setting has been reached. The setting is from 0 to 60 minutes. Pressing the **OK** key confirms the selection. The numeric value is shown in the lower menu when the **Back Light time off** setting is selected.

Demo cycling period: this is adjusted using the DOWN▼ or UP▲ keys until the desired time period has been reached. The setting is from 1 to 60 seconds. Pressing the **OK** key confirms the selection. The numeric value is shown in the lower menu when the **Demo Cycling period** setting is selected.

Figure 13-7 illustrates the **Custom screen menu** structure. The user can browse customise 3 screens to show important information. The desired measurement is selected using the DOWN▼ or UP▲ keys and then pressing the **OK** key to confirm. The **RIGHT** or **LEFT** keys are used to move the cursor to the next measurement. Pressing the **OK** key confirms the selection and returns to the **LCD Menu**

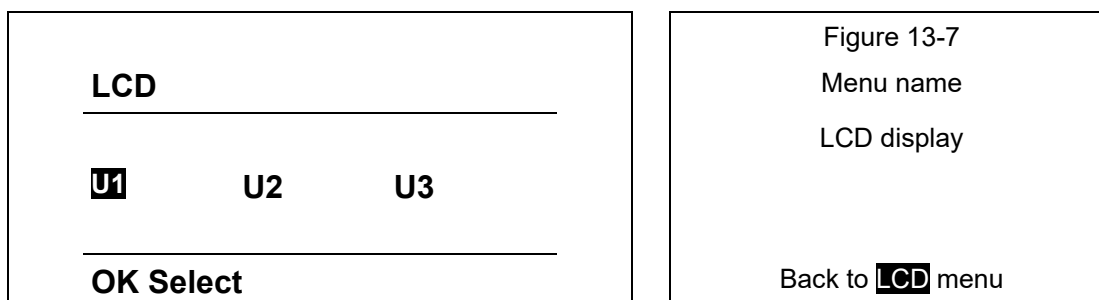

12.4 Security Navigation

Figure 13-8 illustrates the **Security menu** structure. The user can browse through the available settings using the direction keys, by pressing the DOWN▼ or UP▲ keys and then pressing the **OK** key to make a selection. The ◀LEFT key is pressed to return to the **Settings Menu**.

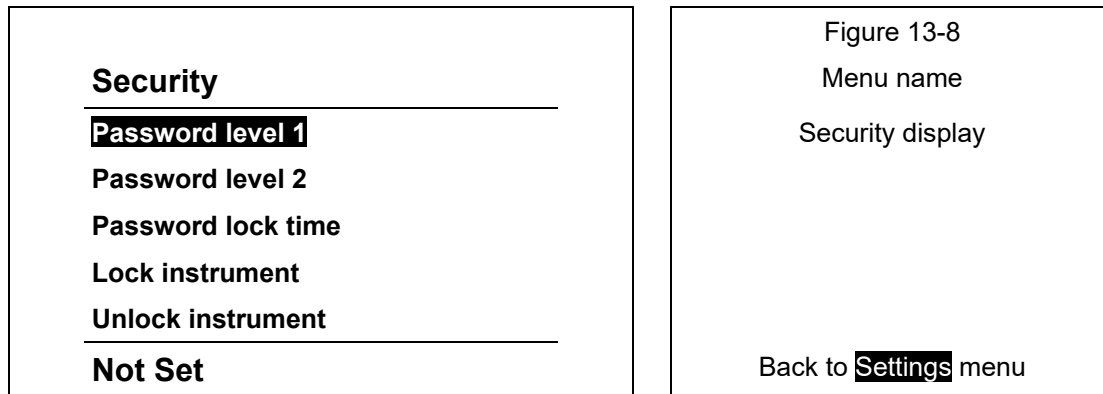
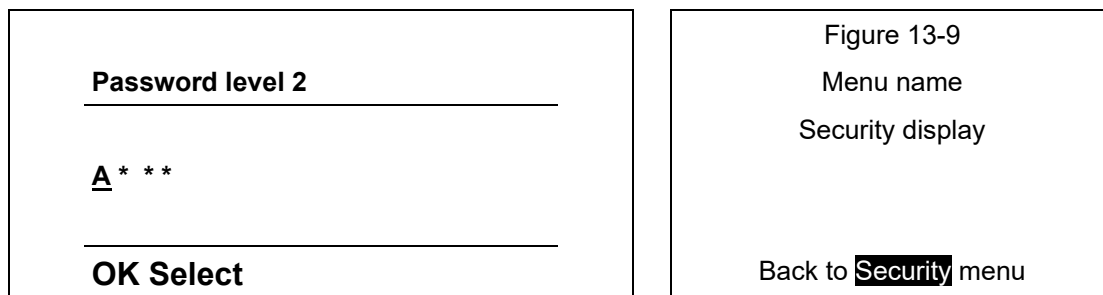

Figure 13-9 illustrates the **Password level 2** setting. The user can change the password, which is 4 characters long, by pressing the DOWN▼ or UP▲ keys and then pressing the **OK** key to make a selection. The ◀LEFT key is pressed to return to the **Security Menu**. Password level 1 has the same structure.



There are 3 levels of security:

L0 – no password required so the user can view and change any of the **M2x2** settings.

L1 – level 1 password: reset all the maximum demand measurements and energy counters.

L2 – level 2 password: the user cannot change any of the settings without a password.

If the password is lost or forgotten, contact technical support for the factory allocated password and provide the serial number of the **M2x2** instrument.

Password lock time: this is adjusted using the DOWN▼ or UP▲ keys until the desired lock time setting has been reached. The setting is from 0 to 60 minutes. Pressing the **OK** key confirms the selection. The numeric value is shown in the lower menu when the **Password Lock time** setting is selected.

Lock instrument: by entering the password the security is activated. This is adjusted using the DOWN▼ or UP▲ keys until each desired character is displayed, then RIGHT▶ or LEFT◀ keys for each position. Pressing the **OK** key confirms the selection. The **Enabled Level ?** will appear in the lower menu when the **Lock instrument** or **unlock instrument** setting is selected.

12.5 Energy Navigation

Figure 13-10 illustrates the **Energy menu** structure. The user can browse through the available menus using the direction keys, by pressing the DOWN▼ or UP▲ keys and then pressing the **OK** key to make a selection. The ◀LEFT key is pressed to return to the **Setting Menu**.

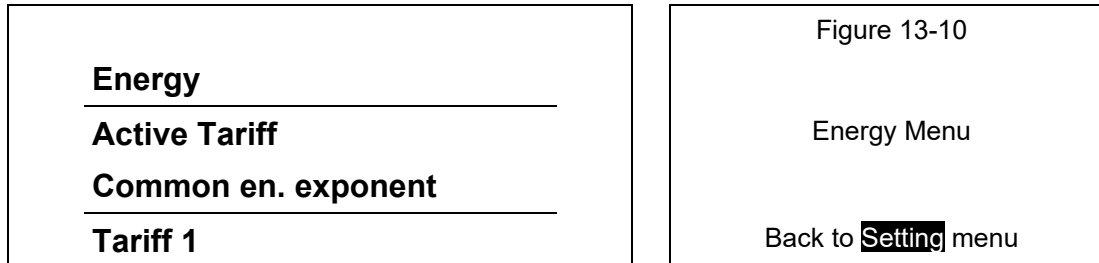

Figure 13-11 illustrates the **Active Tariff menu** structure. The user can browse through the available menus using the direction keys, by pressing the DOWN▼ or UP▲ keys and then pressing the **OK** key to make a selection. The ◀LEFT key is pressed to return to the **Setting Menu**.

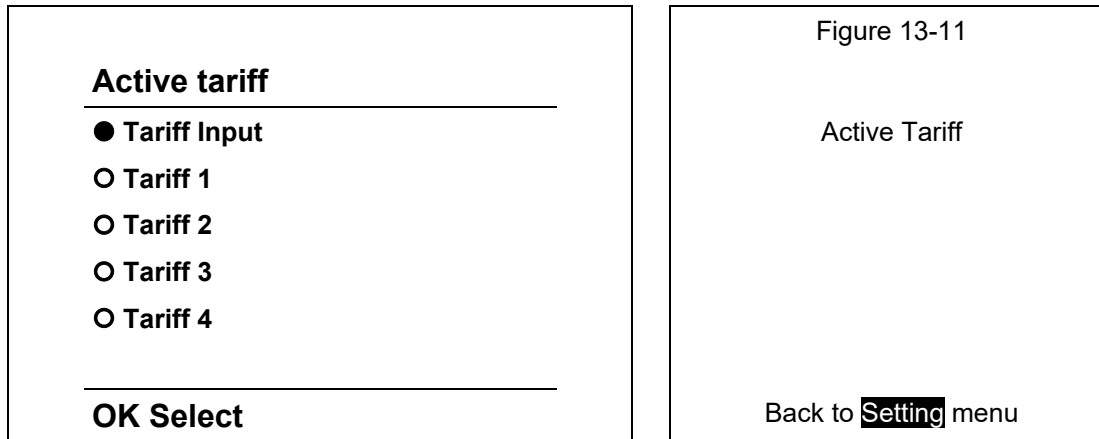
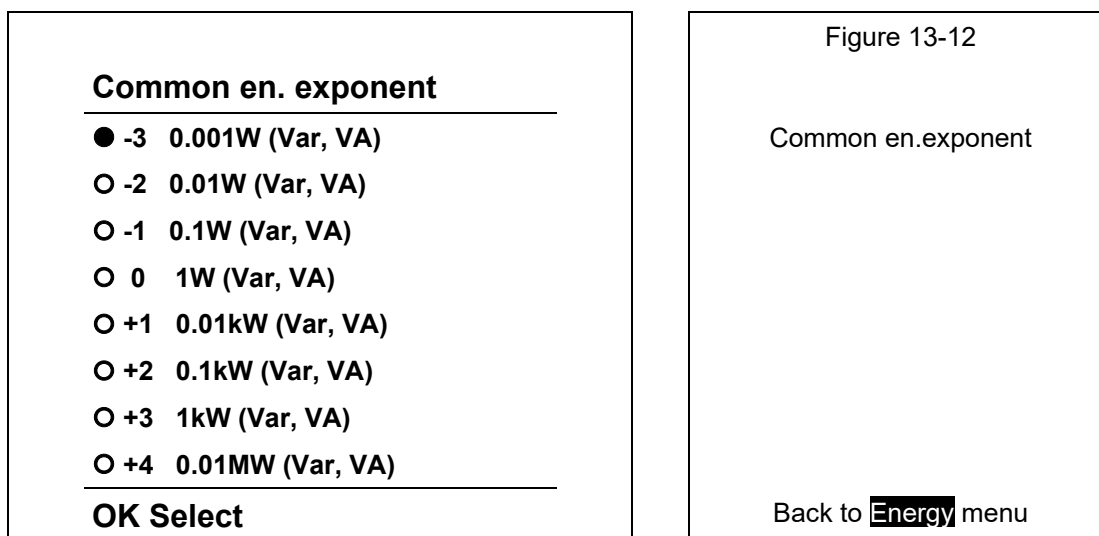

Figure 13-12 illustrates the **Common en.exponent menu** structure. The user can browse through the 5 available menus using the direction keys, by pressing the DOWN▼ or UP▲ keys and then pressing the **OK** key to make a selection. The ◀LEFT key is pressed to return to the **Energy Menu**.



12.6 Inputs and Outputs

Figure 13-3 illustrates the **Settings menu** structure. To select the Input/Output options the user presses the DOWN▼ or UP▲ keys and then pressing the **OK** key to select **Inputs and Outputs**. The ◀LEFT key is pressed to return to the **Main Menu**.

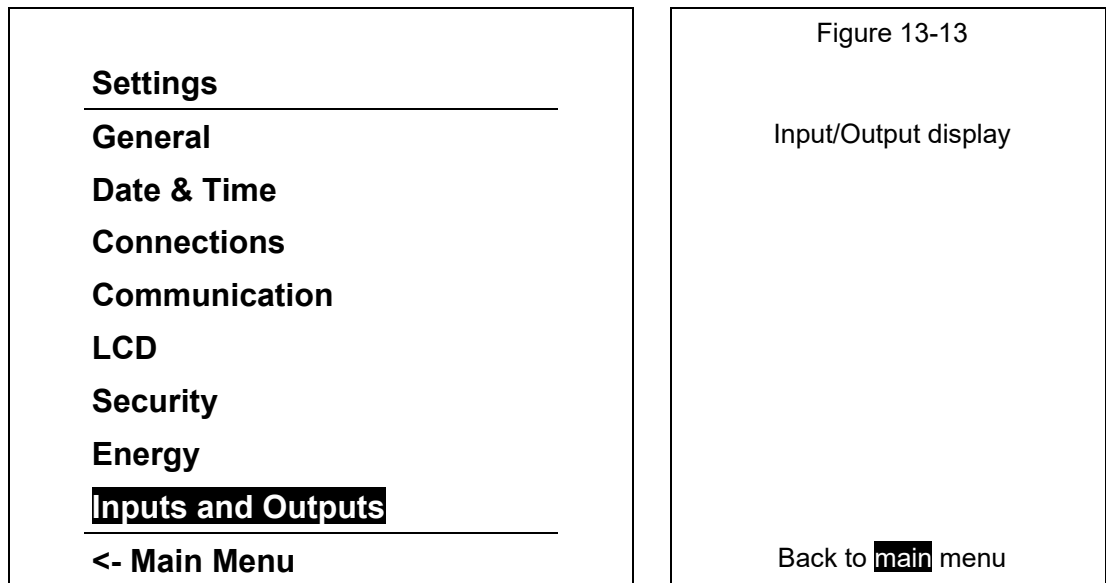

Figure 13-4 illustrates the **I/O menu** structure. To select the Input/Output options the user presses the DOWN▼ or UP▲ keys and then pressing the **OK** key to select. The bottom menu indicates what type of I/O is fitted in each of the four modules. The ◀LEFT key is pressed to return to the **Setting Menu**.

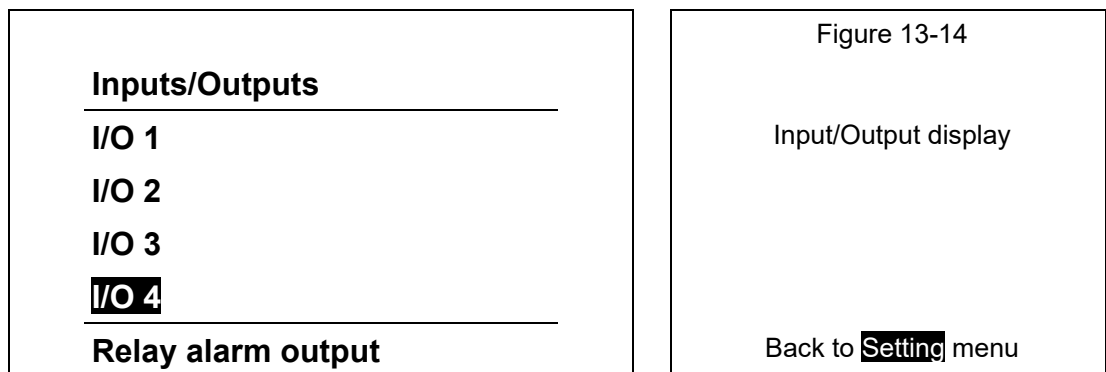
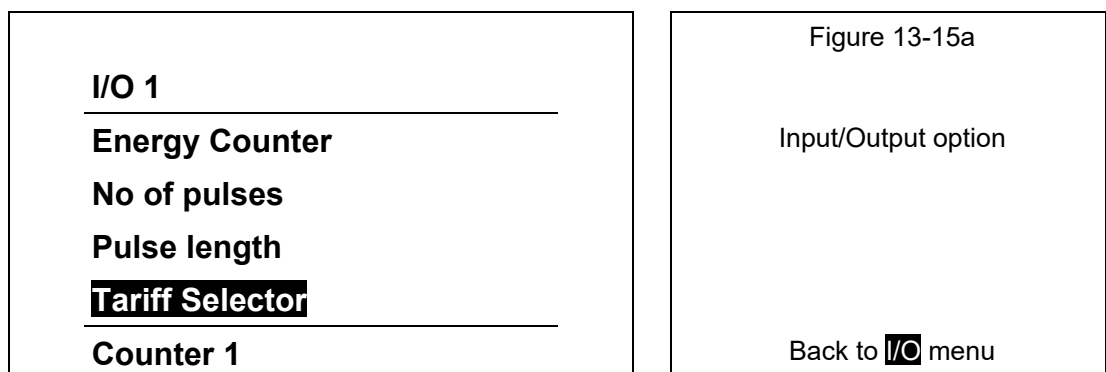

Figure 13-5a illustrates the **I/O option** structure. To select the Input/Output options the user presses the DOWN▼ or UP▲ keys and then pressing the **OK** key to select. The bottom menu indicates what type of I/O is fitted. The ◀LEFT key is pressed to return to the **I/O Menu**.



The Energy Counter can be defined as an Alarm Output or as a pulse output for Counter 1 to 4. Therefore any of the 4 Energy counter registers can be assigned to either of the pulse outputs.

If defined as a counter the display shown in Figure 13-15a appears. The Tariff Selector defines for which tariffs the pulse output is active.

If the Energy Counter is defined as an Alarm Output (**M232** only) the display shown in Figure 13-15b appears

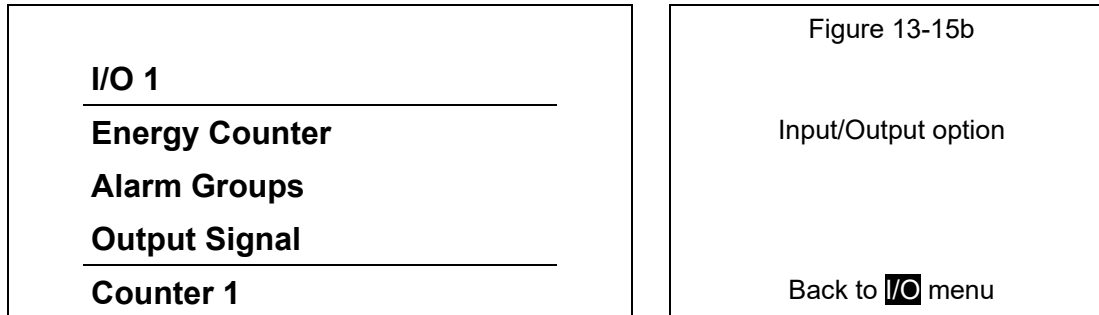

When the alarm function is enabled the options for alarm groups and an output signal appear on the menu structure. The alarm group menu is shown in Figure 13-15c.

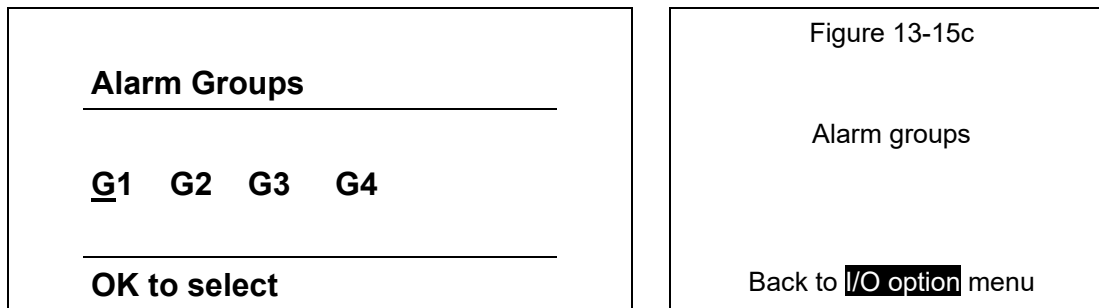

This output signal has a number of options as shown in Figure 13-15d, press the DOWN▼ or UP▲ keys to move between options and then pressing the **OK** key to select

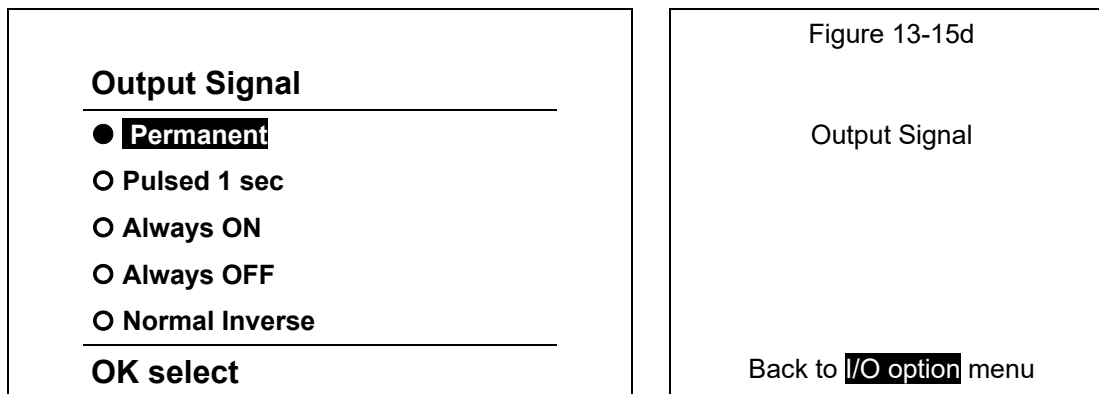

13. COMMUNICATIONS

13.1 Communications ports

The **M232** is fitted with a primary communications (COM1) port which can be RS232, RS485 or USB.

The communication parameters of the **M232** can be obtained by using the keypad and display or by using the 'Scan the network' feature in the QDSP setting software.

13.2 QDSP Setting and Monitoring Software

See the separate QDSP Manual for details of how to Install and use the QDSP Software.

13.3 MODBUS

For details, see Appendix A.

14. TECHNICAL DATA

INPUTS AND SUPPLY		
Voltage Input	Nominal Voltage (U_n)	230 V_{LN} / 415 V_{LL}
	Rating	75 V_{LN} / 230 V_{LN} 120 V_{LL} / 415 V_{LL}
	Max Allowed value	277 V_{LN} , 480 V_{LL} permanently 2 x U_n for 10 seconds
	Minimum range	2V sinusoidal
	Burden	<0.1 VA per phase
Current Input	Nominal current (I_n)	5A
	Rating (Auto-ranging)	1A/5A
	Overload	3 x I_n continuously 25 x I_n for 3 seconds 50 x I_n for 1 second
	Minimal range	Starting current for power
	Maximum range	12.5A sinusoidal
	Burden	<0.1 VA per phase
Frequency	Nominal Frequency (F_n)	50/ 60Hz
	Measuring range	16 to 400Hz
	Rating	10 to 1000 Hz
Supply Universal	Nominal AC voltage	48 to 276Vac
	Nominal frequency	40 to 70Hz
	Nominal DC voltage	20 to 300Vdc
	Burden	< 5 VA

CONNECTIONS	
Permitted conductor cross sections	Maximum conductor cross section
Voltage terminals (4)	≤ 5mm ² one conductor
Current terminals (3)	≤ 6mm diameter conductor with insulation
Supply (2)	≤ 2.5mm ² one conductor
Modules (3 x 3)	≤ 2.5mm ² one conductor

ACCURACY		(of range unless specified)
RMS Current ($I_1, I_2, I_3, I_{avg}, I_n$)	1A	Class 0.5
	5A	Class 0.5
Maximum Current	12.5A	Class 0.5 (of reading)
RMS Line Voltage (U_1, U_2, U_3, U_{avg})	75V L-N	Class 0.5
	250V L-N	Class 0.5
	500V L-N	Class 0.5
Maximum Voltage	600V	Class 0.5 (of reading)
RMS Phase-Phase Voltage ($U_{12}, U_{23}, U_{31}, U_{avg}$)	120V L-L	Class 0.5
	400V L-L	Class 0.5
	800V L-L	Class 0.5
Frequency		
Frequency (actual)	50/60 Hz	0.01Hz
Nominal Frequency Range	16...400 Hz	0.02 Hz
Power Angle	-180...0...180°	Class 0.5
Power Factor	-1...0...+1	
	U = 50 ... 120 % U_n	Class 2.0
	I = 2 % ... 20 % I_n	Class 1.0
	I = 20 % ... 200 % I_n	
Maximum Demand	Calculated from U and I	Class 1.0
THD	5 to 500V	Class 0.5
	0 to 400%	Class 0.5
Power		
Active W	Calculated from U and I	Class 0.5
Reactive VAR: Q, apparent VA : S	Calculated from U and I	Class 1
Energy		
Active Energy	Calculated from U and I	Class 1 to EN62053-21
Reactive Energy	Calculated from U and I	Class 2 to EN 62053-23

Note: – All measurements are calculated with high harmonic signals. For voltage up to 65 Hz, harmonics up to 32nd are measured.

MODULES		
Energy Pulse (Alarm) module	No of outputs	2
	Max. switching power	40 VA
	Max. switching voltage AC	40 V
	Max. switching voltage DC	35 V
	Max switching current	1 A
	Insulation	1000V ac between open contacts
		4000V ac between coil and contacts
	Pulse	Max 4000 imp/hour, Min width 100ms
	Modes	Normal, pulsed or permanent
Tariff Module	No of inputs	2
	Voltage	230V/110V ± 20% AC

COMMUNICATION			
	RS232	RS485	USB
Connection	Direct	Network	Direct
Max connection length	3m	1000m	3m
Connection	Terminals (3 pin)	Terminals (3 pin)	Type B
Transmission mode	Asynchronous		
Protocol	MODBUS RTU		
Insulation	In accordance with EN 61010-1: 2002 standard		
Transfer rate	1200 to 115200b/s		Automatic

ELECTRONIC FEATURES	
LCD	
Type	Graphic LCD
Size	128 x 64 dots
LCD refreshing	Every 200 ms
Response time	
Input – screen	All calculations are averaged over an interval of between 8 to 256 periods. Preset interval is 64 periods, which is 1.28 second at 50 Hz. (adjustable on M232)
Input – communication	
Input – alarm	
LED's	
Pulse output	Red Energy flow
Alarm (MC330 only)	Red Fulfilled condition for alarm

SAFETY FEATURES		
General	In compliance with EN61010-1:2002 600Vrms, installation category II 300Vrms, installation category III Pollution degree 2	
Test voltage	3.7KV, 1minute In compliance with EN61010-1:2002	
EMC	Directive on electromagnetic compatibility 2004/108/EC In compliance with EN 61326-1: 1998	
Protection	In compliance with EN60529:1997 Front: IP52 Rear with protection cover: IP20	
Ambient conditions	Climatic	class 3, in compliance with EN62052-11:2004 and EN62052-21:2005
	Temperature	Operation -5 to +55C Storage -25 to +70C
	Humidity	≤ 90%RH
	Height	0 to 2000M
Enclosure	DIN	PC incombustibility – self extinguishing in compliance with UL94VO
	Mass	Approx 500g

15. WIRING DIAGRAMS AND CASE DIMENSIONS

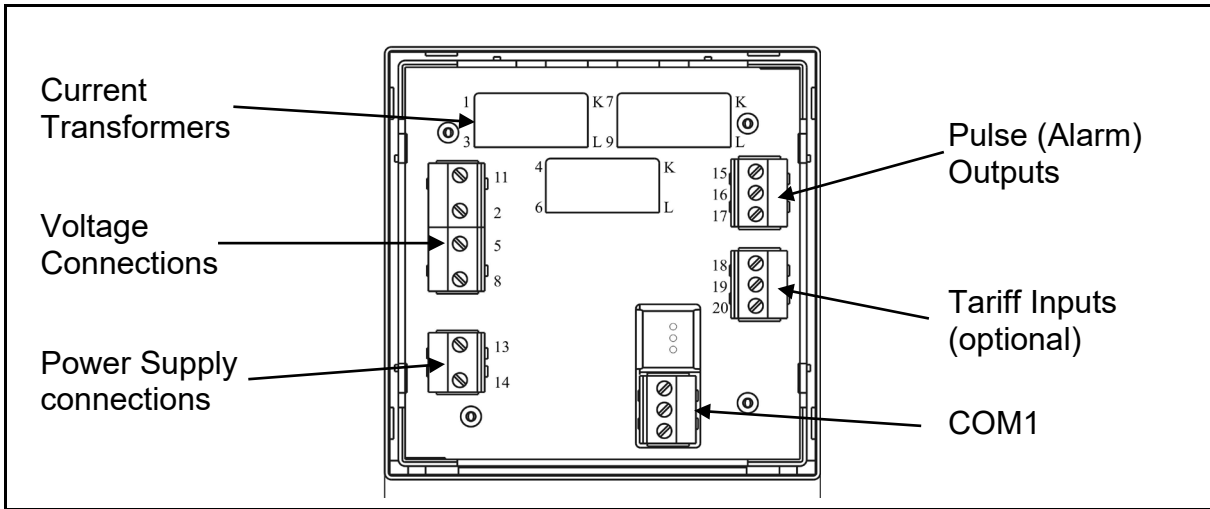

FIGURE 16-1: CONNECTIONS

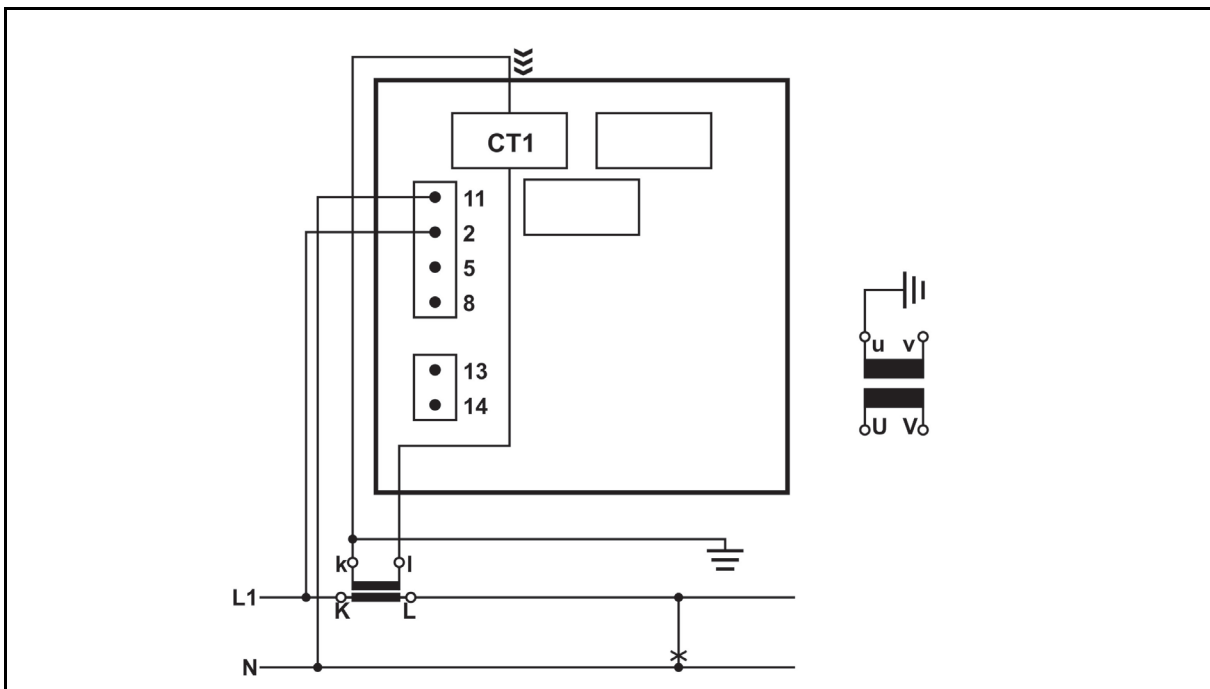

FIGURE 16-2: EXTERNAL WIRING DIAGRAM: SINGLE PHASE (1B)

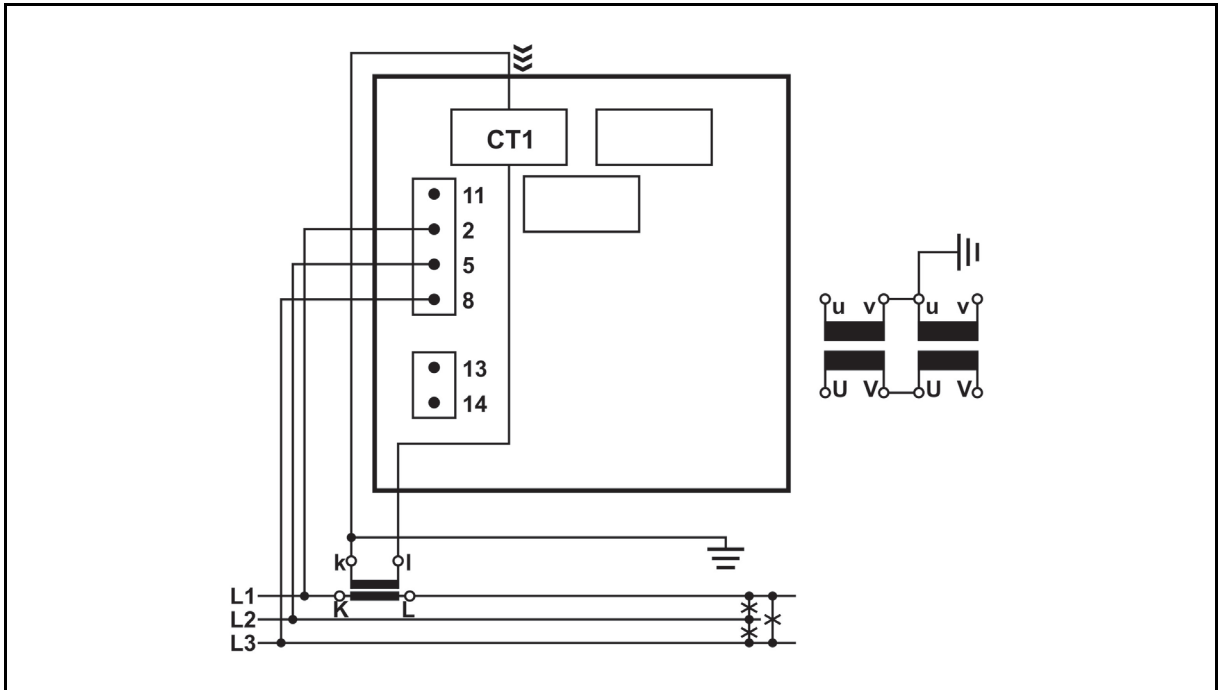

FIGURE 1615-3: EXTERNAL WIRING DIAGRAM: 3-PHASE, 3-WIRE BALANCED LOAD (3B)

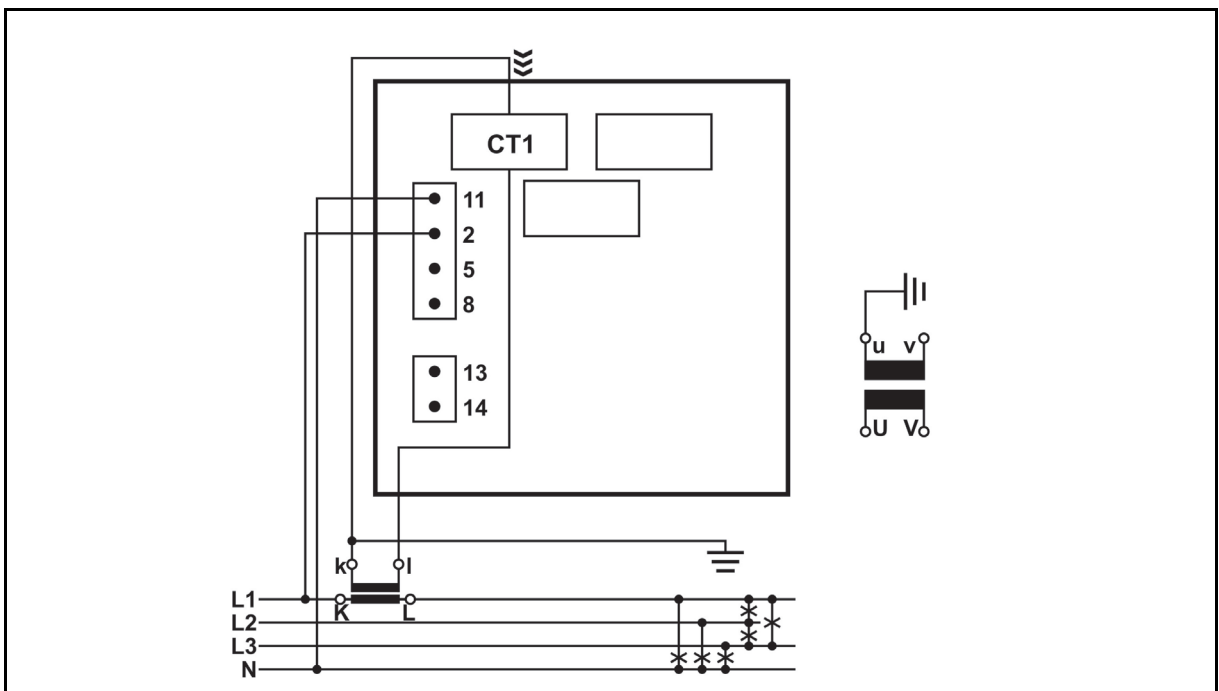

FIGURE 16-4: EXTERNAL WIRING DIAGRAM: 3-PHASE, 4-WIRE BALANCED LOAD (4B)

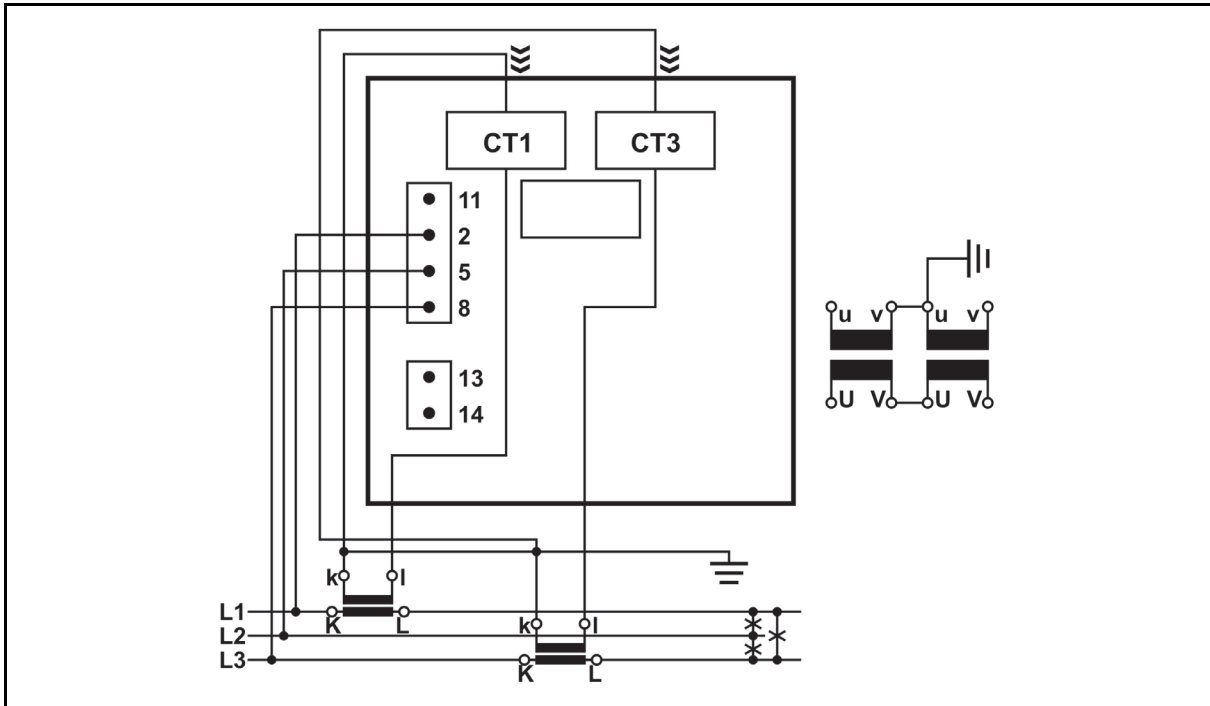

FIGURE 16-5: EXTERNAL WIRING DIAGRAM: 3-PHASE, 3-WIRE UNBALANCED LOAD (3U)

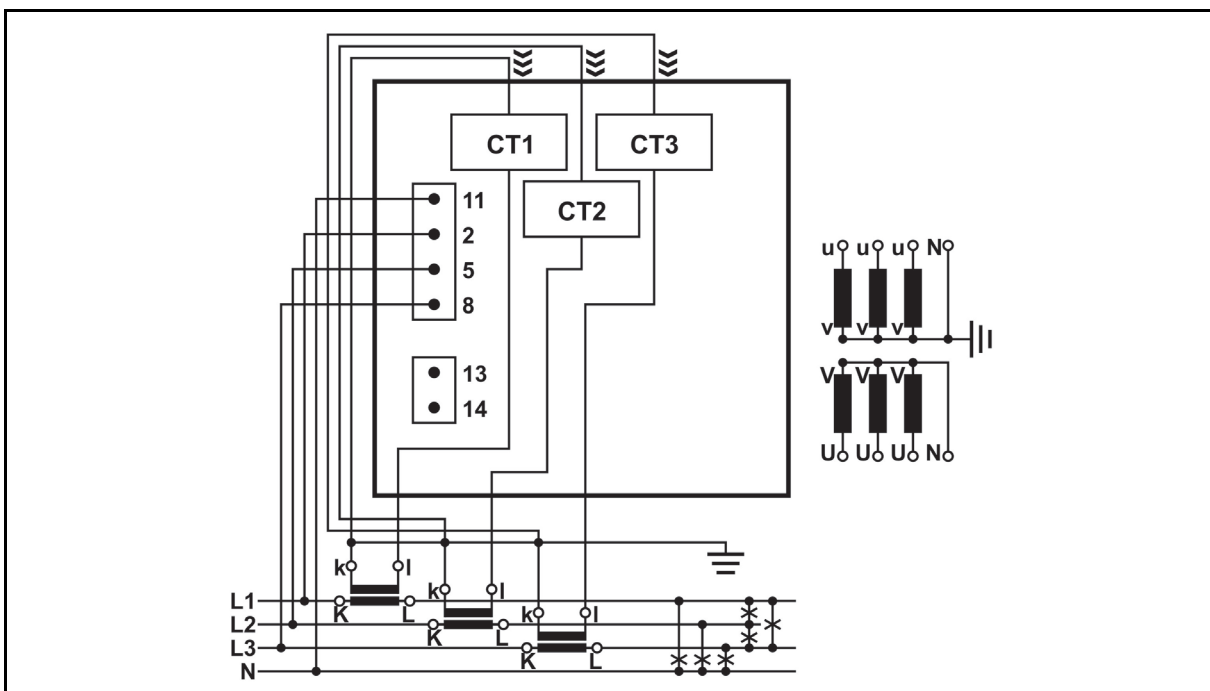

FIGURE 16-6: EXTERNAL WIRING DIAGRAM: 3-PHASE, 4-WIRE UNBALANCED LOAD (4U)

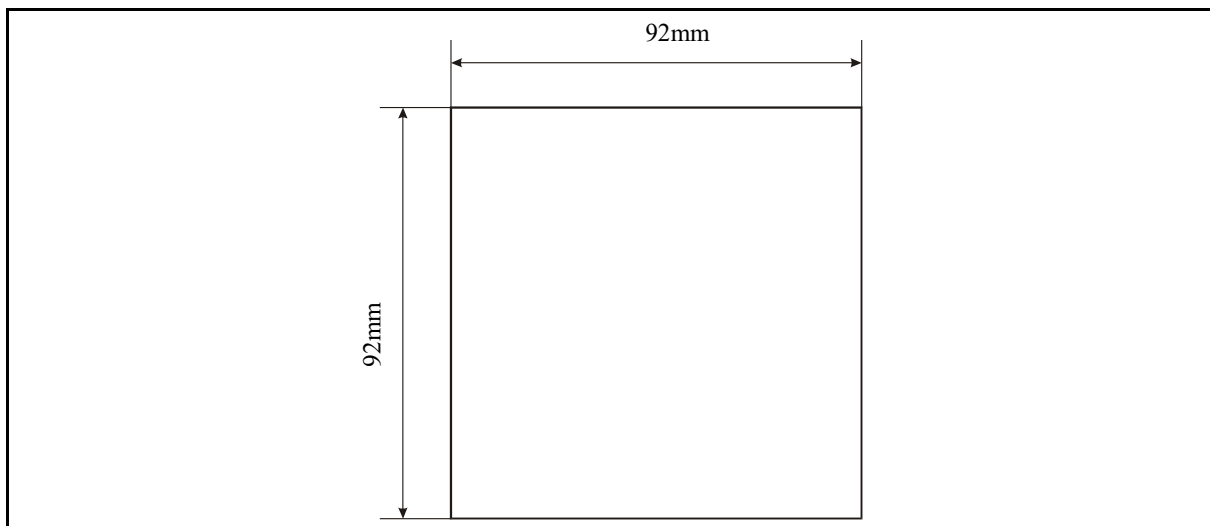

FIGURE 16-7 : CUT OUT

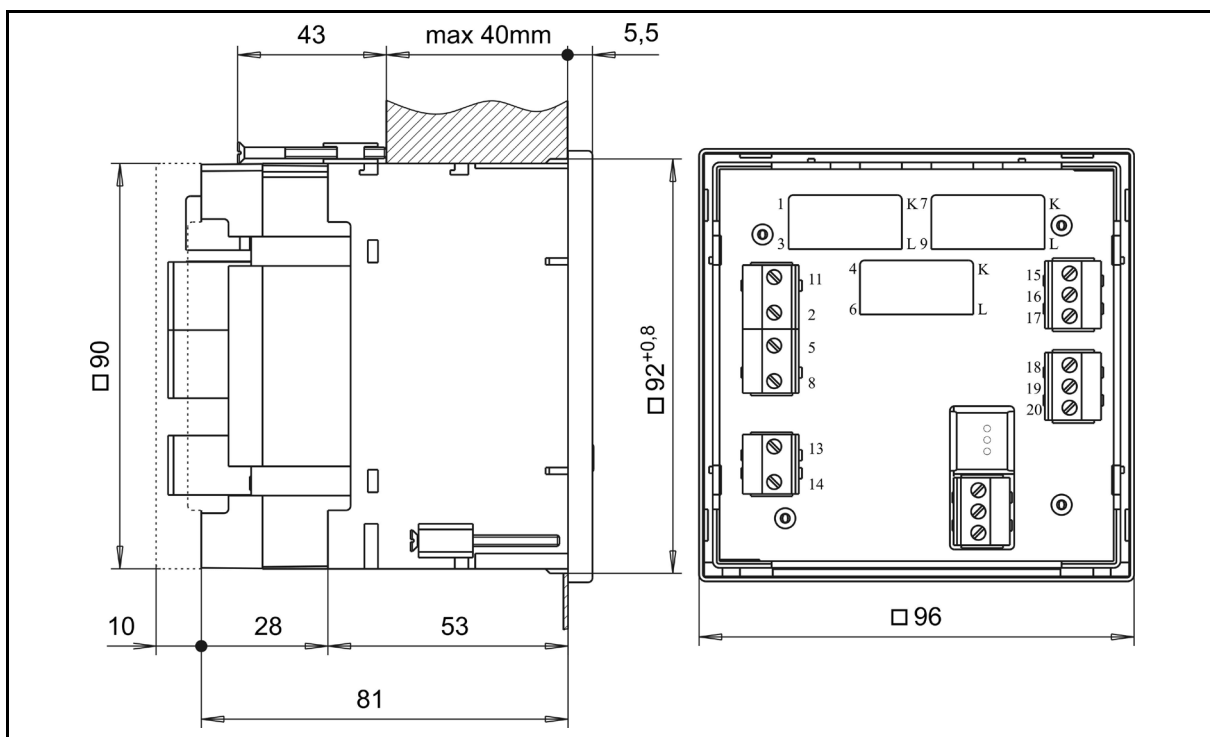

FIGURE 16-8: CASE DIMENSIONS

16. RELATED DOCUMENTS

Ref	Document
1	QDSP: iSTAT Configuration and Analysis Software Manual

17. APPENDIX A: MODBUS PROTOCOL

17.1 Modbus communication protocol

Modbus protocol is enabled via the RS232 or RS485 communication port on the **M232**.

Modbus protocol enables operation of the device on Modbus networks. For the **M232** the Modbus protocol enables point to point (for example Device to PC) communication via RS232 communication and multi drop communication via RS485 communication.

The memory reference for input and holding registers is 30000 and 40000 respectively. Most Modbus master devices assume that 30001 or 40001 are subtracted from the defined address for the registers. The M2x2 subtracts 30000 and 40000, meaning that the addresses may have to be offset by 1.

Using MODBUS register 40100 (MODBUS table for measurements) the required register map can be selected. Value “0” is M233 compatible register map. Value “1” is M231 compatible register map. This selection can also be done during commissioning using QDSP.

17.2 Register Map for Actual Measurements

Parameter	Type	M233 Compatible Register map		M231 Compatible Register map	
		Start	End	Start	End
Voltage U ₁	T5	30107	30108	30044	30045
Voltage U ₂	T5	30109	30110	30046	30047
Voltage U ₃	T5	30111	30112	30048	30049
Average phase Voltage U [~]	T5	30113	30114	30042	30043
Phase to phase voltage U ₁₂	T5	30118	30119	30081	30082
Phase to phase voltage U ₂₃	T5	30120	30121	30083	30084
Phase to phase voltage U ₃₁	T5	30122	30123	30085	30086
Average phase to phase Voltage U _{pp~}	T5	30124	30125	30079	30080
Current I ₁	T5	30126	30127	30036	30037
Current I ₂	T5	30128	30129	30038	30039
Current I ₃	T5	30130	30131	30040	30041
Total Current I	T5	30138	30139	30034	30035
Neutral current I _n	T5	30132	30133	30074	30075
Real Power P ₁	T6	30142	30143	30020	30021
Real Power P ₂	T6	30144	30145	30022	30023
Real Power P ₃	T6	30146	30147	30024	30025
Total Real Power P	T6	30140	30141	30018	30019
Reactive Power Q ₁	T6	30150	30151	30028	30029
Reactive Power Q ₂	T6	30152	30153	30030	30031
Reactive Power Q ₃	T6	30154	30155	30032	30033
Total Reactive Power Q	T6	30148	30149	30026	30027
Apparent Power S ₁	T5	30158	30159	30052	30053
Apparent Power S ₂	T5	30160	30161	30054	30055
Apparent Power S ₃	T5	30162	30163	30056	30057

Parameter	Type	M233 Compatible Register map		M231 Compatible Register map	
		Start	End	Start	End
Total Apparent Power S	T5	30156	30157	30050	30051
Power Factor PF ₁	T7	30166	30167	30060	30061
Power Factor PF ₂	T7	30168	30169	30062	30063
Power Factor PF ₃	T7	30170	30171	30064	30065
Total Power Factor PF	T7	30164	30165	30058	30059
Power Angle U ₁ -I ₁	T2			30071	
Power Angle U ₁ -I ₁	T17	30173			
Power Angle U ₂ -I ₂	T2			30072	
Power Angle U ₂ -I ₂	T17	30174			
Power Angle U ₃ -I ₃	T2			30073	
Power Angle U ₃ -I ₃	T17	30175			
Power Angle atan2(Pt, Qt)	T2			30070	
Power Angle atan2(Pt, Qt)	T17	30172			
Angle U ₁ -U ₂	T2			30076	
Angle U ₁ -U ₂	T17	30115			
Angle U ₂ -U ₃	T2			30077	
Angle U ₂ -U ₃	T17	30116			
Angle U ₃ -U ₁	T2			30078	
Angle U ₃ -U ₁	T17	30117			
Frequency f	T5	30105	30106		
Frequency f (mHz)	T1			30066	
THD I ₁	T16	30188		30118	
THD I ₂	T16	30189		30119	
THD I ₃	T16	30190		30120	
THD U ₁	T16	30182		30112	
THD U ₂	T16	30183		30113	
THD U ₃	T16	30184		30114	
THD U ₁₂	T16	30185		30115	
THD U ₂₃	T16	30186		30116	
THD U ₃₁	T16	30187		30117	
Max Demand Since Last RESET					
MD Real Power P (positive)	T6	30542	30543		
MD Real Power P (negative)	T6	30548	30549		
MD Reactive Power Q - L	T6	30554	30555		
MD Reactive Power Q - C	T6	30560	30561		
MD Apparent Power S	T5	30536	30537		
MD Current I ₁	T5	30518	30519		
MD Current I ₂	T5	30524	30525		

Parameter	Type	M233 Compatible Register map		M231 Compatible Register map	
		Start	End	Start	End
MD Current I ₃	T5	30530	30531		
Dynamic Demand Values					
MD Real Power P (positive)	T6	30510	30511		
MD Real Power P (negative)	T6	30512	30513		
MD Reactive Power Q – L	T6	30514	30515		
MD Reactive Power Q –	T6	30516	30517		
MD Apparent Power S	T5	30508	30509		
MD Current I ₁	T5	30502	30503		
MD Current I ₂	T5	30504	30505		
MD Current I ₃	T5	30506	30507		
Energy					
Energy Counter 1 Exponent	T2	30401		30006	
Energy Counter 2 Exponent	T2	30402		30007	
Energy Counter 3 Exponent	T2	30403		30008	
Energy Counter 4 Exponent	T2	30404		30009	
Counter E1	T3	30406	30407	30010	30011
Counter E2	T3	30408	30409	30012	30013
Counter E3	T3	30410	30411	30014	30015
Counter E4	T3	30412	30413	30016	30017
Active tariff	T1	30405		30133	
Internal Temperature	T17	30181		30128	

17.3 Register table for IEEE 754 Measurements

Parameter	Type	M233 Compatible Register map		M231 Compatible Register map	
		Start	End	Start	End
Uavg (phase to neutral)	T_float	32484	32485		
Uavg (phase to phase)	T_float	32486	32487		
ΣI	T_float	32488	32489		
Active Power Total (Pt)	T_float	32490	32491		
Reactive Power Total (Qt)	T_float	32492	32493		
Apparent Power Total (St)	T_float	32494	32495		
Power Factor Total (PFt)	T_float	32496	32497		
Frequency	T_float	32498	32499		
U1	T_float	32500	32501	31530	31531
U2	T_float	32502	32503	31532	31533

Parameter	Type	M233 Compatible Register map		M231 Compatible Register map	
		Start	End	Start	End
U3	T_float	32504	32505	31534	31535
Uavg (phase to neutral)	T_float	32506	32507	31516	31517
U12	T_float	32508	32509	31536	31537
U23	T_float	32510	32511	31538	31539
U31	T_float	32512	32513	31540	31541
Uavg (phase to phase)	T_float	32514	32515	31518	31519
I1	T_float	32516	32517	31524	31525
I2	T_float	32518	32519	31526	31527
I3	T_float	32520	32521	31528	31529
ΣI	T_float	32522	32523	31514	31515
I neutral (calculated)	T_float	32524	32525	31522	31523
I neutral (measured)	T_float	32526	32527		
Iavg	T_float	32528	32529	31520	31521
Active Power Phase L1 (P1)	T_float	32530	32531	31542	31543
Active Power Phase L2 (P2)	T_float	32532	32533	31544	31545
Active Power Phase L3 (P3)	T_float	32534	32535	31546	31547
Active Power Total (Pt)	T_float	32536	32537	31508	31509
Reactive Power Phase L1 (Q1)	T_float	32538	32539	31548	31549
Reactive Power Phase L2 (Q2)	T_float	32540	32541	31550	31551
Reactive Power Phase L3 (Q3)	T_float	32542	32543	31552	31553
Reactive Power Total (Qt)	T_float	32544	32545	31510	31511
Apparent Power Phase L1 (S1)	T_float	32546	32547	31554	31555
Apparent Power Phase L2 (S2)	T_float	32548	32549	31556	31557
Apparent Power Phase L3 (S3)	T_float	32550	32551	31558	31559
Apparent Power Total (St)	T_float	32552	32553	31512	31513
Power Factor Phase 1 (PF1)	T_float	32554	32555		
Power Factor Phase 2 (PF2)	T_float	32556	32557		
Power Factor Phase 3 (PF3)	T_float	32558	32559		
Power Factor Total (PFt)	T_float	32560	32561		
CAP/IND P. F. Phase 1 (PF1)	T_float	32562	32563		
CAP/IND P. F. Phase 2 (PF2)	T_float	32564	32565		
CAP/IND P. F. Phase 3 (PF3)	T_float	32566	32567		
CAP/IND P. F. Total (PFt)	T_float	32568	32569		
$\varphi 1$ (angle between U1 and I1)	T_float	32570	32571		
$\varphi 2$ (angle between U2 and I2)	T_float	32572	32573		
$\varphi 3$ (angle between U3 and I3)	T_float	32574	32575		
Power Angle Total (atan2(Pt,Qt))	T_float	32576	32577		
$\varphi 12$ (angle between U1 and U2)	T_float	32578	32579		

Parameter	Type	M233 Compatible Register map		M231 Compatible Register map	
		Start	End	Start	End
φ23 (angle between U2 and U3)	T_float	32580	32581		
φ31 (angle between U3 and U1)	T_float	32582	32583		
Frequency	T_float	32584	32585		
U unbalance	T_float	32586	32587		
I1 THD%	T_float	32588	32589		
I2 THD%	T_float	32590	32591		
I3 THD%	T_float	32592	32593		
U1 THD%	T_float	32594	32595		
U2 THD%	T_float	32596	32597		
U3 THD%	T_float	32598	32599		
U12 THD%	T_float	32600	32601		
U23 THD%	T_float	32602	32603		
U31 THD%	T_float	32604	32605		
MAX DEMAND SINCE LAST RESET					
Active Power Total (Pt) - (positive)	T_float	32606	32607		
Active Power Total (Pt) - (negative)	T_float	32608	32609		
Active Power Total	T_float			31568	31569
Reactive Power Total (Qt) - L	T_float	32610	32611		
Reactive Power Total (Qt) - C	T_float	32612	32613		
Total Reactive Power	T_float			31570	31571
Apparent Power Total (St)	T_float	32614	32615	31572	31573
I1	T_float	32616	32617		
I2	T_float	32618	32619		
I3	T_float	32620	32621		
Average I	T_float			31574	31575
DYNAMIC DEMAND VALUES					
Active Power Total (Pt) - (positive)	T_float	32622	32623		
Active Power Total (Pt) - (negative)	T_float	32624	32625		
Active Power Total	T_float			31560	31561
Reactive Power Total (Qt) - L	T_float	32626	32627		
Reactive Power Total (Qt) - C	T_float	32628	32629		
Total Reactive Power	T_float			31562	31563
Apparent Power Total (St)	T_float	32630	32631	31564	31565
I1	T_float	32632	32633		
I2	T_float	32634	32635		
I3	T_float	32636	32637		
I3	T_float	32636	32637		
Average I	T_float			31566	31567

Parameter	Type	M233 Compatible Register map		M231 Compatible Register map	
		Start	End	Start	End
ENERGY					
Energy Counter 1	T_float	32638	32639	31500	31501
Energy Counter 2	T_float	32640	32641	31502	31503
Energy Counter 3	T_float	32642	32643	31504	31505
Energy Counter 4	T_float	32644	32645	31506	31507
Energy Counter 1 Cost	T_float	32646	32647		
Energy Counter 2 Cost	T_float	32648	32649		
Energy Counter 3 Cost	T_float	32650	32651		
Energy Counter 4 Cost	T_float	32652	32653		
Total Energy Counter Cost	T_float	32654	32655		
Active Tariff	T_float	32656	32657		
Internal Temperature	T_float	32658	32659		

17.4 Register table for the normalized actual measurements

(Only available when the M233 compatible register map is selected)

Parameter	MODBUS		100% value
	Register	Type	
Voltage U_1	30801	T16	Un
Voltage U_2	30802	T16	Un
Voltage U_3	30803	T16	Un
Average phase Voltage U_{\sim}	30804	T16	Un
Phase to phase voltage U_{12}	30805	T16	Un
Phase to phase voltage U_{23}	30806	T16	Un
Phase to phase voltage U_{31}	30807	T16	Un
Average phase to phase Voltage $U_{pp\sim}$	30808	T16	Un
Current I_1	30809	T16	In
Current I_2	30810	T16	In
Current I_3	30811	T16	In
Total Current I	30812	T16	It
Neutral current I_n	30813	T16	In
Average Current I_{\sim}	30815	T16	In
Real Power P_1	30816	T17	Pn
Real Power P_2	30817	T17	Pn
Real Power P_3	30818	T17	Pn
Total Real Power P	30819	T17	Pt

Parameter	MODBUS		100% value
	Register	Type	
Reactive Power Q_1	30820	T17	Pn
Reactive Power Q_2	30821	T17	Pn
Reactive Power Q_3	30822	T17	Pn
Total Reactive Power Q	30823	T17	Pt
Apparent Power S_1	30824	T16	Pn
Apparent Power S_2	30825	T16	Pn
Apparent Power S_3	30826	T16	Pn
Total Apparent Power S	30827	T16	Pt
Power Factor PF_1	30828	T17	1
Power Factor PF_2	30829	T17	1
Power Factor PF_3	30830	T17	1
Total Power Factor PF	30831	T17	1
CAP/IND P.F. Phase 1 (PF_1)	30832	T17	1
CAP/IND P.F. Phase 2 (PF_2)	30833	T17	1
CAP/IND P.F. Phase 3 (PF_3)	30834	T17	1
CAP/IND P.F. Total (PFt)	30835	T17	1
Power Angle U_1-I_1	30836	T17	100°
Power Angle U_2-I_2	30837	T17	100°
Power Angle U_3-I_3	30838	T17	100°
Power Angle $\text{atan2}(Pt, Qt)$	30839	T17	100°
Angle U_1-U_2	30840	T17	100°
Angle U_2-U_3	30841	T17	100°
Angle U_3-U_1	30842	T17	100°
Frequency	30843	T17	$F_n+10\text{Hz}$
THD I_1	30845	T16	100%
THD I_2	30846	T16	100%
THD I_3	30847	T16	100%
THD U_1	30848	T16	100%
THD U_2	30849	T16	100%
THD U_3	30850	T16	100%
THD U_{12}	30851	T16	100%
THD U_{23}	30852	T16	100%
THD U_{31}	30853	T16	100%
Max Demand Since Last Reset			
MD Real Power P (positive)	30854	T16	Pt
MD Real Power P (negative)	30855	T16	Pt
MD Reactive Power Q - L	30856	T16	Pt
MD Reactive Power Q - C	30857	T16	Pt

Parameter	MODBUS		100% value
	Register	Type	
MD Apparent Power S	30858	T16	Pt
MD Current I ₁	30859	T16	In
MD Current I ₂	30860	T16	In
MD Current I ₃	30861	T16	In
Dynamic Demand Values			
MD Real Power P (positive)	30862	T16	Pt
MD Real Power P (negative)	30863	T16	Pt
MD Reactive Power Q – L	30864	T16	Pt
MD Reactive Power Q – C	30865	T16	Pt
MD Apparent Power S	30866	T16	Pt
MD Current I ₁	30867	T16	In
MD Current I ₂	30868	T16	In
MD Current I ₃	30869	T16	In
Energy			
Energy Counter 1	30870	T17	Actual counter value MOD 20000 is returned
Energy Counter 2	30871	T17	
Energy Counter 3	30872	T17	
Energy Counter 4	30873	T17	
Active Tariff	30879	T1	
Internal Temperature	30880	T17	100°

17.5 100% values calculations for normalized measurements

Un =	$(R40147 / R40146) * R30015 * R40149$
In =	$(R40145 / R40144) * R30017 * R40148$
Pn =	Un*In
It =	In Connection Mode: 1b
It =	3*In Connection Modes: 3b, 4b, 3u, 4u
Pt =	Pn Connection Mode: 1b
Pt =	3*Pn Connection Modes: 3b, 4b, 3u, 4u
Fn =	R40150

Register	Content	Type
30015	Calibration voltage	T4
30017	Calibration current	T4

Rxxxx are Modbus register numbers, see above and section 18.6 for descriptions.

It is suggested that these values are read regularly to ensure any changes made in the settings are incorporated in the calculation.

As the nominal input ranges of the **M2x2** are 500V and 5A, the Used voltage range and Used Current range need to be set correctly to obtain the highest resolution normalized values. These values are set using the QDSP software.

17.6 Register table for the basic settings

Register	Content	Type	Ind	Values / Dependencies	Min	Max	P. Level
40143	Connection Mode	T1	0	No mode	1	5	2
			1	1b - Single Phase			
			2	3b - 3 phase 3 wire balanced			
			3	4b - 3 phase 4 wire balanced			
			4	3u - 3 phase 3 wire unbalanced			
			5	4u - 3 phase 4 wire unbalanced			
40144	CT Secondary	T4		mA			2
40145	CT Primary	T4		A/10			2
40146	VT Secondary	T4		mV			2
40147	VT Primary	T4		V/10			2
40148	Current input range (%)	T16		10000 for 100%	5,00	200,00	2
40149	Voltage input range (%)	T16		10000 for 100%	2,50	100,00	2
40150	Frequency nominal value	T1		Hz	10	1000	2

17.7 Data types decoding

Type	Bit mask	Description
T1		Unsigned Value (16 bit) Example: 12345 = 3039(16)
T2		Signed Value (16 bit) Example: -12345 = CFC7(16)
T3		Signed Long Value (32 bit) Example: 123456789 = 075B CD 15(16)
T4	bits # 15...14 bits # 13...00	Short Unsigned float (16 bit) Decade Exponent(Unsigned 2 bit) Binary Unsigned Value (14 bit) Example: 10000*102 = A710(16)
T5	bits # 31...24 bits # 23...00	Unsigned Measurement (32 bit) Decade Exponent(Signed 8 bit) Binary Unsigned Value (24 bit) Example: 123456*10-3 = FD01 E240(16)
T6	bits # 31...24 bits # 23...00	Signed Measurement (32 bit) Decade Exponent (Signed 8 bit) Binary Signed value (24 bit) Example: - 123456*10-3 = FDFE 1DC0(16)
T7	bits # 31...24 bits # 23...16 bits # 15...00	Power Factor (32 bit) Sign: Import/Export (00/FF) Sign: Inductive/Capacitive (00/FF) Unsigned Value (16 bit), 4 decimal places Example: 0.9876 CAP = 00FF 2694(16)
T9	bits # 31...24 bits # 23...16 bits # 15...08 bits # 07...00	Time (32 bit) 1/100s 00 - 99 (BCD) Seconds 00 - 59 (BCD) Minutes 00 - 59 (BCD) Hours 00 - 24 (BCD) Example: 15:42:03.75 = 7503 4215(16)
T10	bits # 31...24 bits # 23...16 bits # 15...00	Date (32 bit) Day of month 01 - 31 (BCD) Month of year 01 - 12 (BCD) Year (unsigned integer) 1998..4095 Example: 10, SEP 2000 = 1009 07D0(16)
T16		Unsigned Value (16 bit), 2 decimal places Example: 123.45 = 3039(16)
T17		Signed Value (16 bit), 2 decimal places Example: -123.45 = CFC7(16)

Type	Bit mask	Description
T_Str4		Text: 4 characters (2 characters for 16 bit register)
T_Str6		Text: 6 characters (2 characters for 16 bit register)
T_Str8		Text: 8 characters (2 characters for 16 bit register)
T_Str16		Text: 16 characters (2 characters for 16 bit register)
T_Str40		Text: 40 characters (2 characters for 16 bit register)
T_float	bits # 31 bits # 30..23 bits # 22..0	IEEE 754 Floating-Point Single Precision Value (32 bit) Sign Bit (1 bit) Exponent Field (8 bit) Significand (23 bit) Example: 123.45 stored as 123.45000 = 42F6 E666(16)

18. APPENDIX B: CALCULATIONS & EQUATIONS

18.1 Definitions of symbols

No	Symbol	Definition
1	M_v	Sample factor
2	M_P	Average interval
3	U_f	Phase voltage (U_1, U_2 or U_3)
4	U_{ff}	Phase-to-phase voltage (U_{12}, U_{23} or U_{31})
5	N	Total number of samples in a period
6	n	Sample number ($0 \leq n \leq N$)
7	x, y	Phase number (1, 2 or 3)
8	i_n	Current sample n
9	u_{fn}	Phase voltage sample n
10	u_{ffn}	Phase-to-phase voltage sample n
11	φ_f	Power angle between current and phase voltage f (φ_1, φ_2 or φ_3)

18.2 Equations

Voltage

$$U_f = \sqrt{\frac{\sum_{n=1}^N u_n^2}{N}}$$

Phase voltage

N – 128 samples in one period (up to 65 Hz)

N – 128 samples in M_v periods (above 65Hz)

Example: 400 Hz $\rightarrow N = 7$

$$U_{xy} = \sqrt{\frac{\sum_{n=1}^N (u_{xn} - u_{yn})^2}{N}}$$

Phase-to-phase voltage

u_x, u_y – phase voltages (U_f)

N – a number of samples in a period

Current

$$I_{RMS} = \sqrt{\frac{\sum_{n=1}^N i_n^2}{N}}$$

Phase current

N – 128 samples in a period (up to 65 Hz)

N – 128 samples in more periods (above 65 Hz)

$$I_n = \sqrt{\frac{\sum_{n=1}^N (i_{1n} + i_{2n} + i_{3n})^2}{N}}$$

Neutral current

i – n sample of phase current (1, 2 or 3)

N = 128 samples in a period (up to 65 Hz)

Power

$$P_f = \frac{1}{N} \cdot \sum_{n=1}^N (u_{fn} \cdot i_{fn})$$

Active power by phases

N – a number of periods

n – a number of samples in a period

f – phase designation

$$P_t = P_1 + P_2 + P_3$$

Total active power

t – total power

1, 2, 3 – phase designation

Sign $Q_f(\varphi)$

$$\varphi \in [0^\circ - 180^\circ] \Rightarrow \text{Sign}Q_f(\varphi) = +1$$

$$\varphi \in [180^\circ - 360^\circ] \Rightarrow \text{Sign}Q_f(\varphi) = -1$$

Reactive power sign Q_f – reactive power (by phases) φ – power angle

$$S_f = U_f \cdot I_f$$

Apparent power by phases U_f – phase voltage I_f – phase current

$$S_t = S_1 + S_2 + S_3$$

Total apparent power S_{123} – apparent power by phases

$$Q_f = \text{Sign}Q_f(\varphi) \cdot \sqrt{S_f^2 - P_f^2}$$

Reactive power by phases S_f – apparent power by phases P_f – active power by phases

$$Q_t = Q_1 + Q_2 + Q_3$$

Total reactive power Q_f – reactive power by phases

$$\varphi_s = \arctan 2(P_t, Q_t)$$

$$\varphi_s = [-180^\circ, 179,99^\circ]$$

Total power angle P_t – total active power S_t – total apparent power

$$\text{PF}_t = \frac{P_t}{S_t}$$

3 phase power factor P_t – total active power S_t – total apparent power

$$\text{PF}_f = \frac{P_f}{S_f}$$

Power factor by phases P_f – phase active power S_f – phase apparent power

THD

$$I_f \text{THD}(\%) = \frac{\sqrt{\sum_{n=2}^{63} I_n^2}}{I_1} \cdot 100$$

Current THD

I_1 – value of first harmonic

n – number of harmonic

$$U_f \text{THD}(\%) = \frac{\sqrt{\sum_{n=2}^{63} U_f n^2}}{U_{f1}} \cdot 100$$

Phase voltage THD

U_1 – value of first harmonic

n – number of harmonic

$$U_{ff} \text{THD}(\%) = \frac{\sqrt{\sum_{n=2}^{63} U_{ff} n^2}}{U_{ff1}} \cdot 100$$

Phase-to-phase voltage THD

U_1 – value of first harmonic

n – number of harmonic



Imagination at work

Grid Solutions
St Leonards Building
Redhill Business Park
Stafford, ST16 1WT, UK
+44 (0) 1785 250 070
www.gegridsolutions.com/contact

© 2020 General Electric Company Corporation. All rights reserved. Information contained in this document is indicative only. No representation or warranty is given or should be relied on that it is complete or correct or will apply to any particular project. This will depend on the technical and commercial circumstances. It is provided without liability and is subject to change without notice. Reproduction, use or disclosure to third parties, without express written authority, is strictly prohibited.

M2x2/EN/M/F