

GE Energy Connections

SMTB4™

Compact IEC® Test Block and Plug System

Key Benefits

- Flexibility and features to meet electrical utility and industrial requirements for safe, reliable and efficient testing
- Enables the testing of protection relays and meters with no interruption of the power circuit
- Reduces man-hours for testing and trouble-shooting
- Compact size with multiple mounting and wiring provisions
- Designed and qualified for the unique needs of the protection and control industry
- Advanced security, robustness and reliability in harsh industrial environments
- No disruption to existing connections or relay settings needed for testing purposes

Application

- Isolate relays and meters from instrument transformers and inject current/voltage into the devices to quickly and safely verify system protection and measurement performance
- Automatically short CT secondaries with use of available test plug with internal CT shorting links
- Calibrate meters and control devices

- The Test Plug can be connected continuously to the Test Block in order to supply current or voltage to secondary circuit sub-assemblies
- Perform testing on up to four independent circuits on one test block
- Measure output of CT's and VT's with or without disconnecting devices from the circuit

Features

- Color coded to differentiate between current and voltage circuits
- Test plug for safely shorting current circuits before isolating current operated devices
- Surface, flush, semi-flush and G32 DIN rail mounting provisions
- Locking system for securing plug to base
- Easily identifiable "Live" and "Equipment" test sockets
- Space saving compact design
- Designed for harsh industrial environments
- Front (surface, semi-flush, and DIN rail) and rear (flush and semi-flush) access wiring
- Screw clamp, ring tongue, and quick connect termination provisions for up to 2.5 mm² wire CE, RoHS, and REACH certified



Test Block

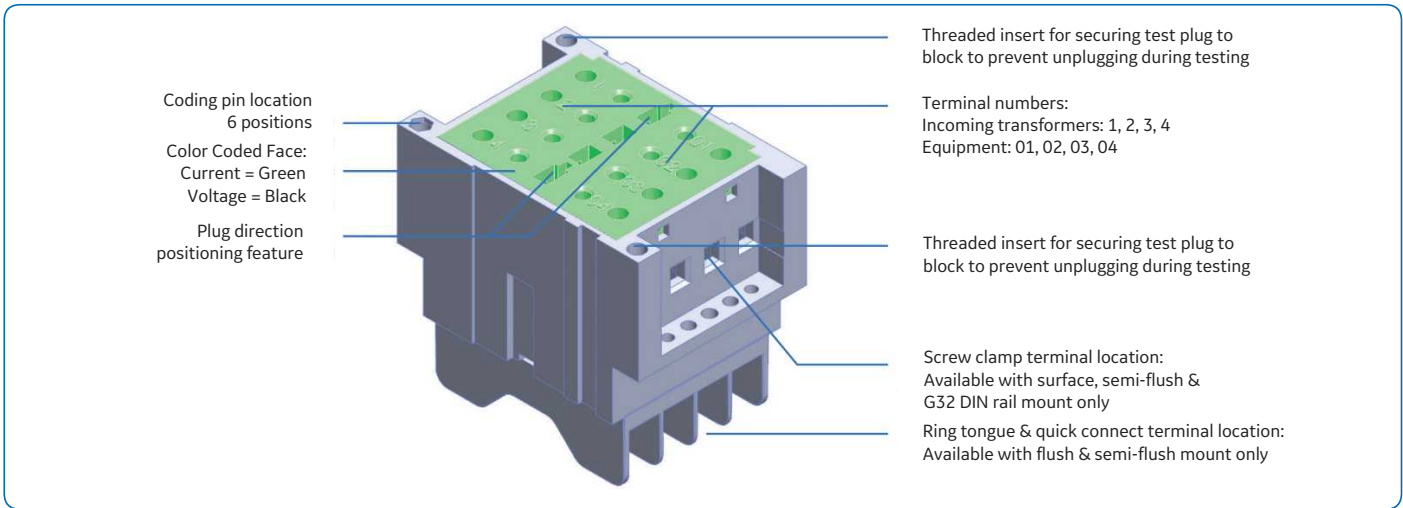

Test Block Details

Dimensions (for reference only) are shown below for the four (4) different test block mounting styles available. Part numbers for the different styles are shown on page 7. Flush mount and DIN rail adapter kits are available in kit form.

Surface Mount

Available with screw clamp terminations only

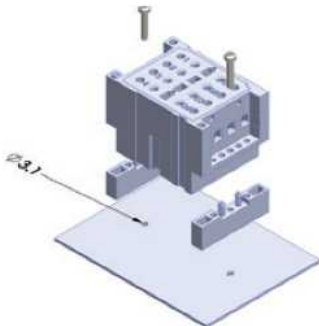

Test Block Outline

Overall dimensions apply to all test blocks; however, rear provision for ring tongue and quick connect terminations is not provided for surface and DIN rail mounting styles

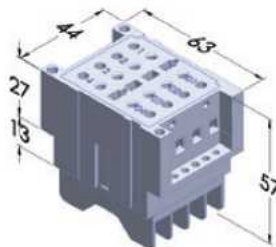

Flush Mount

Available with ring tongue and quick connect terminations only

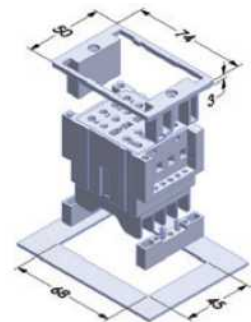

Semi-Flush Mount

Available with ring tongue, quick connect, and screw clamp terminations

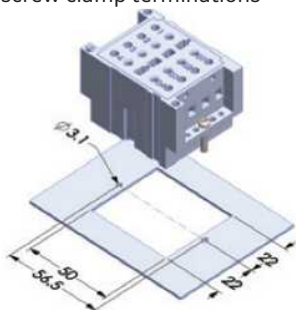

Test Block Cover

Order part number SMTB4TBLA separately, see page 7

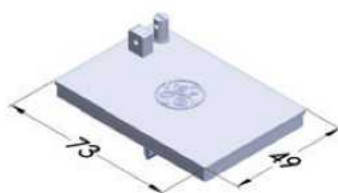

G32 DIN Rail Mount

Available with screw clamp terminations only

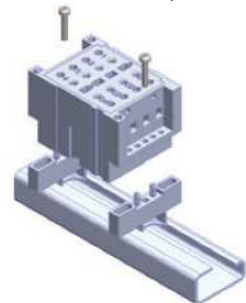

Test Plug

The test plug is available with and without test leads. Insulated plugs are available (see part number on page 7) for user to assemble custom test lead lengths and colors as required. Contact pins are included with both options. Pin crimping and installation instructions are shown below. Plugs are color coded for safety purposes and are designed to provide a convenient and safe means of testing current and voltage circuits. The test plugs are equipped with coding pins for installation by user to ensure proper match between block and plug. Operator safety has been the primary concern during the design of the SMTB4 test block system.

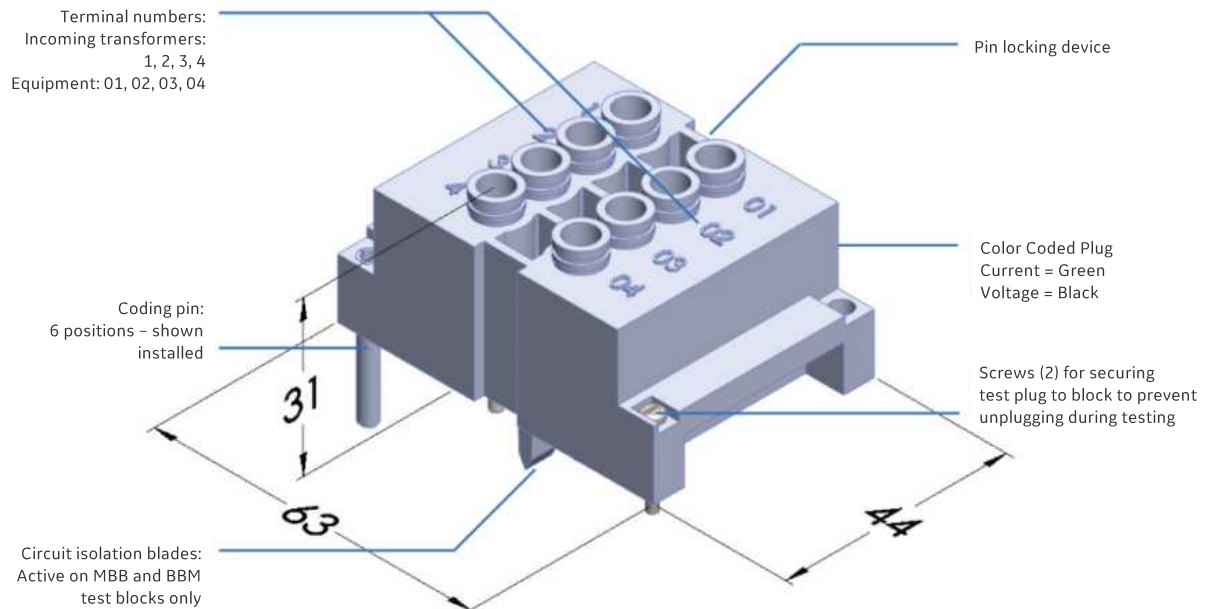

Test Plug Pin Installation

- See pin installation instructions to the right.
- Pre-wired current and voltage plugs without internal shorting
- links supplied with (8) 2.5mm² x 1.7m insulated leads with 4mm
- diameter insulated double test plugs.
- Pre-wired current plugs with internal shorting links supplied with
- (4) 2.5mm² x 1.7m insulated leads with 4 mm diameter insulated double test plugs.
- Leads marked 1, 2, 3, 4 on pre-wired plugs are red.
- Leads marked 01, 02, 03, 04 on pre-wired plugs are black.

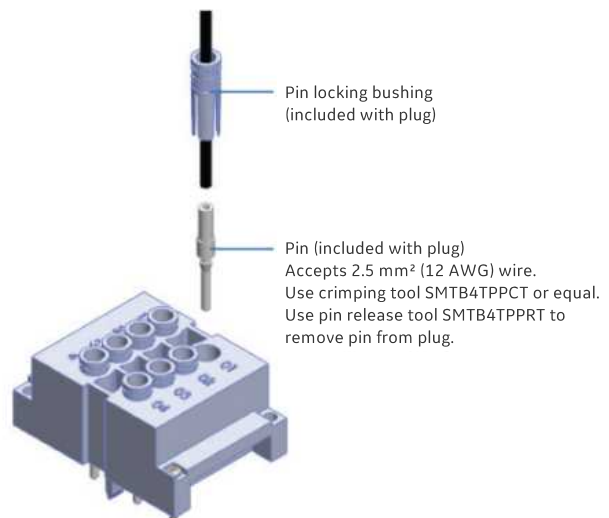

Coding Pin Installation

1. Locate the one hex shaped coding pin provision in the test block corner close to terminal 4 and insert the coding pin from the bottom of the test block into any one of the six available locations. See step 1.
2. Insert the test plug coding pin into the opening left by the test block coding pin. See step 2.
3. Install the test plug into the test block. This will align the two mating coding pins. See step 3.
4. Remove the test plug from the test block and gently tap the coding pin into the plug to make sure it has been properly seated. See step 4.

Step 1

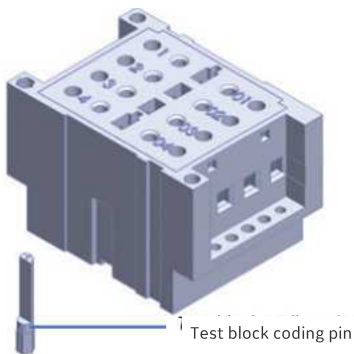

Step 2

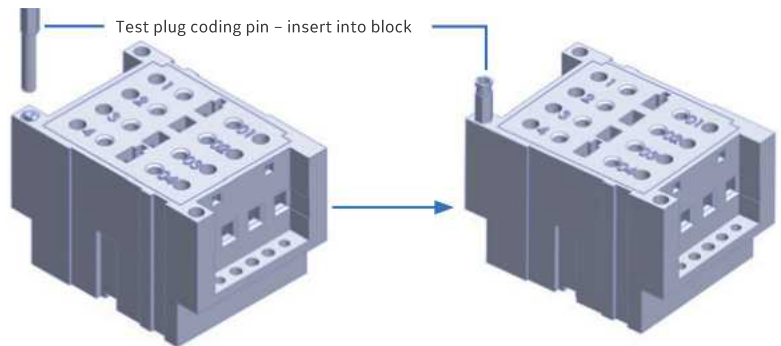

Step 3

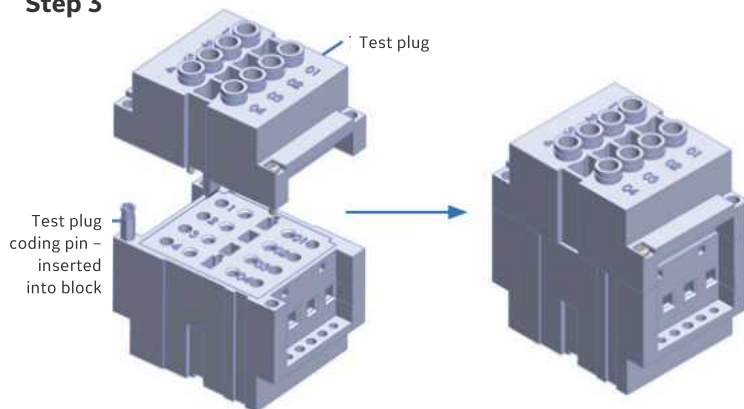

Step 4

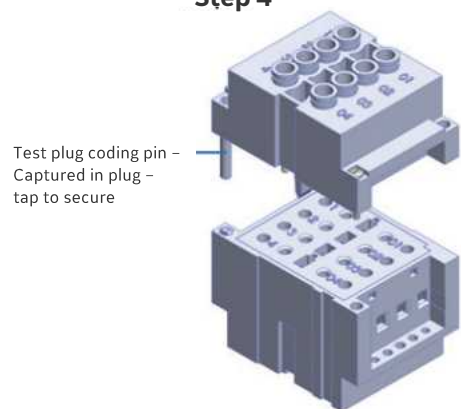

Typical Current Test Block and Plug Applications

Measurement in Service Series

Make Before Break (MBB)

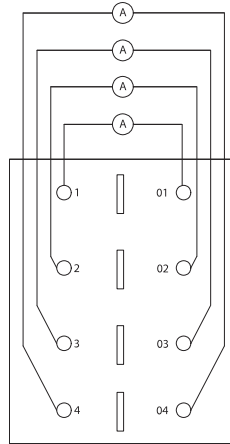

Caution:

All connections must be made to test plug before insertion of test plug into test block

Current Test Plug
SMTB4TPNLCN (Not wired)
SMTB4TPWLCN (Pre-wired)

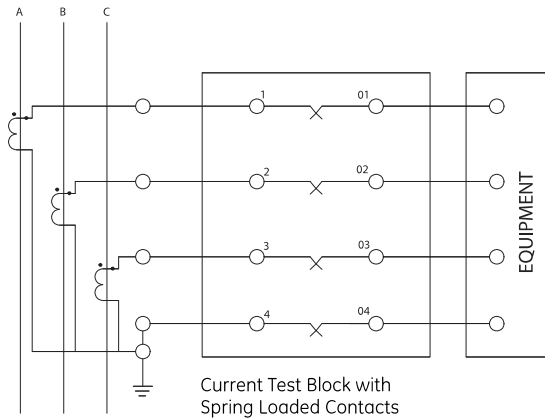

Current Test Block with
Spring Loaded Contacts

Current Injection from Calibrated Source

Make Before Break (MBB)

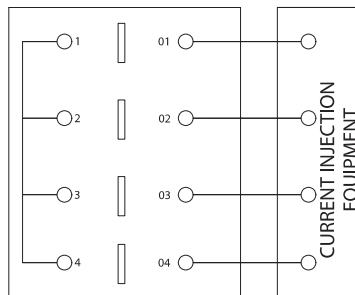

Caution:

If using non-shorted current test plug, terminals 1,2,3, and 4 must be shorted before insertion of test plug into test block

Current Test Plug
SMTB4TPNLCW (Not wired)
SMTB4TPWLCW (Pre-wired)
(Plug shown with terminals 1, 2, 3, & 4 internally shorted)

Typical Voltage Test Block and Plug Applications

Measurement and Voltage Injection

Break Before Make (BBM)
Make Before Break (MBB)

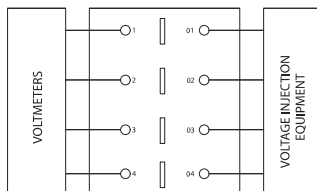

Caution:

All connections must be made to test plug before insertion of test plug into test block

Voltage Test Plug
SMTB4TPNLVN (Not wired, BBM)
SMTB4TPWLVN (Pre-wired, BBM)
SMTB4TPNLVA (Not-wired, MBB)
SMTB4TPWLVA (Pre-wired, MBB)

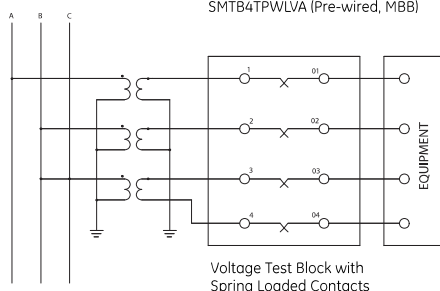

Voltage Test Block with Spring Loaded Contacts

Measurement In-Service

Closed Contact Block

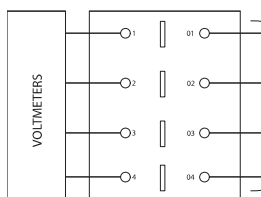

Caution:

These leads not used if using pre-wired plug with 8 leads. Plugs at ends of leads are insulated but caution is necessary as conductors are live.

Voltage Test Plug
SMTB4TPNLVN (Not wired)
SMTB4TPWLVN (Pre-wired)

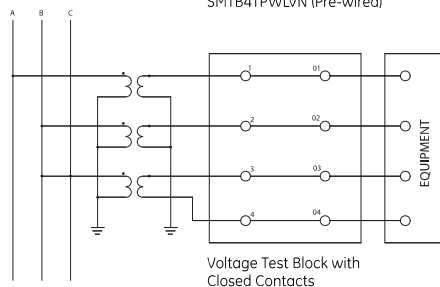

Voltage Test Block with Closed Contacts

Caution Statements

- To avoid high voltage shock hazard, external CT terminals must NOT be open circuited. Shorting links MUST be in place BEFORE Test Plug insertion.
- USERS must ensure that external shorting links are installed for CT secondary windings prior to inserting the Test Plug into the Test Block.
- USERS must ensure that external shorting links are NOT installed on POTENTIAL circuits.
- USERS must ensure that when using test plugs with internally shorted terminals the CTs are wired to the corresponding test block terminals.

SMTB4™ Ordering

Test Block				
Part Number	Type	Contacts	Mounting	Termination
SMTB4TBCSSSC	Current	Spring loaded contact block	Surface	Screw Clamp
SMTB4TBCSFQC	Current	Spring loaded contact block	Flush	Quick-Connect
SMTB4TBCSFRT	Current	Spring loaded contact block	Flush	Ring-Tongue
SMTB4TBCSDSC	Current	Spring loaded contact block	Din Rail	Screw Clamp
SMTB4TBCSHSC	Current	Spring loaded contact block	Semi-Flush	Screw Clamp
SMTB4TBCSHQC	Current	Spring loaded contact block	Semi-Flush	Quick-Connect
SMTB4TBCSHRT	Current	Spring loaded contact block	Semi-Flush	Ring-Tongue
SMTB4TBVSSSC	Voltage	Spring loaded contact block	Surface	Screw Clamp
SMTB4TBVSFQC	Voltage	Spring loaded contact block	Flush	Quick-Connect
SMTB4TBVSFRT	Voltage	Spring loaded contact block	Flush	Ring-Tongue
SMTB4TBVSDSC	Voltage	Spring loaded contact block	Din Rail	Screw Clamp
SMTB4TBVSHSC	Voltage	Spring loaded contact block	Semi-Flush	Screw Clamp
SMTB4TBVSHQC	Voltage	Spring loaded contact block	Semi-Flush	Quick-Connect
SMTB4TBVSHRT	Voltage	Spring loaded contact block	Semi-Flush	Ring-Tongue
SMTB4TBVCSSC	Voltage	Closed contact block	Surface	Screw Clamp
SMTB4TBVCFQC	Voltage	Closed contact block	Flush	Quick-Connect
SMTB4TBVCFRT	Voltage	Closed contact block	Flush	Ring-Tongue
SMTB4TBVCDSC	Voltage	Closed contact block	Din Rail	Screw Clamp
SMTB4TBVCHSC	Voltage	Closed contact block	Semi-Flush	Screw Clamp
SMTB4TBVCHQC	Voltage	Closed contact block	Semi-Flush	Quick-Connect
SMTB4TBVCHRT	Voltage	Closed contact block	Semi-Flush	Ring-Tongue

SMTB4™

Test Plug - No Wiring			
Part Number	Type	Contacts	Shorting
SMTB4TPNLCN	Current	Make-Before-Break	No Shorting
SMTB4TPNLCW	Current	Make-Before-Break	CTs Shorted
SMTB4TPNLVN	Voltage	Break-Before-Make	No Shorting
SMTB4TPNLVA	Voltage	Make-Before-Break	No Shorting

SMTB4™

Test Plug - With Leads			
Part Number	Type	Contacts	Shorting
SMTB4TPWLCN	Current	Make-Before-Break	No Shorting
SMTB4TPWLCW	Current	Make-Before-Break	CTs Shorted
SMTB4TPWLVN	Voltage	Break-Before-Make	No Shorting
SMTB4TPWLVA	Voltage	Make-Before-Break	No Shorting

SMTB4™

Accessories	
Part Number	Description
SMTB44531710	Test plug pin for voltage TP (2.5 mm ²); pkg 25
SMTB44531713	Test plug pin for voltage TP (2.5 mm ²); pkg 25
SMTB4TPPCT	Crimping tool
SMTB4TPPRT	Contact pin release tool
SMTB4453177	Coding pin
SMTB4TBDMK	G32 DIN rail mounting kit
SMTB4TBFMK	Flush mounting kit
SMTB4TPTP	Insulated plugs for TP wiring
SMTB4TBLA	Cover assembly

Specifications

Voltage

Rated 400 V AC/DC
Impulse Withstand 4 kV

Current

Rated 20 A AC
Short Circuit 200 A / 1s AC
100 A / 5 s. AC

Temperature Range

IEC 60255-1 Storage & Transit -25 °C to +70 °C
Operating -25 °C to +55 °C

IP Rating

Front panel IP40 (w/cover)
IP20 (w/o cover)

Maximum Working Voltage

IEC 60255-5:2000 400 V AC or DC continuous

Insulation Withstand

IEC 60255-5:2000 4 kV rms for one minute between poles
and between poles and ground.

Surge

IEC 61000-4-5

Environmental

IEC 60068-2-1/2
IEC 60068-2-78
RoHS / REACH

Mechanical

IEC 60255-21-1/2/3 Class II

EMC

Electromagnetically benign; Excluded from Directive 2004/108/EC

Product Safety

CE 2006/95/EC



GEGridSolutions.com

Grid-AIS-L4-ITL_Model_SMTB4-1578-2017_05-EN. © Copyright 2017. General Electric Company and Instrument Transformers LLC reserve the right to change specifications of described products at any time without notice and without obligation to notify any person of such changes.

Worldwide Contact Center

Web: www.GEGridSolutions.com/contact

Phone: +44 (0) 1785 250 070

USA and Canada: +1 (0) 800 547 8629

Europe, Middle East and Africa: +34 (0) 94 485 88 00