

PowerLink Connect

Powerful HMI for Substation and Control Room Operations

PowerLink™ Connect is designed for organizations in need of safe, efficient and reliable management of electric power delivery. PowerLink Connect enables real-time collection and display of electrical infrastructure information, secure operator supervisory control, and efficient management of energy delivery, all using standards-based communications.

PowerLink Connect connects and communicates with energy management and other I/O devices in your facility, bringing together display, control and reporting functions under one easy-to-use interface, providing a dynamic window into your electrical network.

PowerLink Connect is an open, standards-based solution that's intuitive to configure and easy to own. It's scalable from smaller point count systems (5,000-10,000) to larger, complex electrical networks with utility control rooms (100,000+ points). With intuitive operations and simplified maintenance, PowerLink Connect enables you to ensure optimal operational and electrical performance.

Applications

PowerLink Connect's proven design and wide range of supported electrical and industrial communication protocols enables it to fulfill a range of electrical management applications:

Electric Power Transmission & Distribution

- Substation automation / Substation management
- Secure operator access and control

Large Energy Users

- Site Energy Management
- Operations & management of critical energy delivery
- Substation automation / Substation management

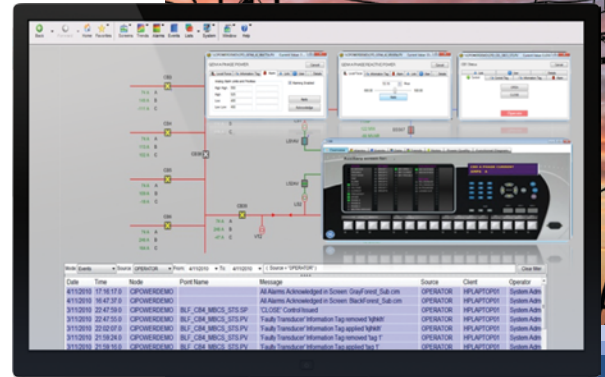

Key Features

- Real-time, dynamic data collection and display
- Remote and secure operator supervisory control
- High availability architecture
- Supports dynamic configuration without system restart
- Consistent control interfaces for different types of equipment
- Scalable – add more device monitoring points as needed
- Manufacturer agnostic (non-GE) equipment integration (supports a range of IED's)
- Alarm & event management
- Historical data storage, trending and reporting
- Mobile / Web-enabled operations

Key Benefits

- Reliable, secure and auditable operations
- Enhanced operational decision making & safety
- Increased productivity & accountability
- Improved operations efficiency
- Extended equipment life
- Lower total cost of ownership
- Reduced configuration & training time
- Reduced downtime & equipment maintenance
- Easy-to-use, familiar and intuitive operator interfaces



Features

PowerLink Connect consolidates data from all of your facility's electrical devices into a single platform and presents it as interactive information in intuitive, easy to use interfaces via secure clients and mobile applications.

Essential Electrical Distribution Management Features

- Real-time data communication, database management, real-time dynamic data display
- Secure operator supervisory control
- Alarm, event, sequence of events
- Historical data collection with real-time and historical trending
- User-based security
- Online configuration

Comprehensive, Customizable Displays

PowerLink Connect aggregates data from gateways and field devices and intelligently presents relevant information in an easy to understand, customizable graphical format with features such as interactive alarms and dynamic text displays to increase operator efficiency. Typical customizable displays include:

- One-line Diagrams
- Alarm / Event
- Trending
- Equipment Detail Pages
- Operator Access Log
- Operator Notes

Menu Navigation

Intuitive menu provides familiar navigation functions such as "Home", "Forward", "Back" and "Favorites". Highly configurable, PowerLink Connect Menu is easy to use and flexible. Integrated security links screen access to user authentication (only screens operators are authorized to access are visible).

Tab Displays

PowerLink Connect provides powerful, centralized equipment monitoring and control interfaces known as Tab Displays. These are one-stop containers for all relevant information and controls for substation equipment. They are consistent and familiar, making HMI substation operations more intuitive and easier to learn. Tab Displays are totally customizable to your operational standards and requirements.

Operator Dialogs

All operations such as issuing a control, placing a control tag, attaching an equipment note, disabling an alarm, etc., are achieved using Operator Dialogs. This provides consistent and intuitive operations. Each equipment type has an Operator Dialog specific to its operational needs. PowerLink Connect dialogs require no programming and are easily configured to meet all operational requirements.

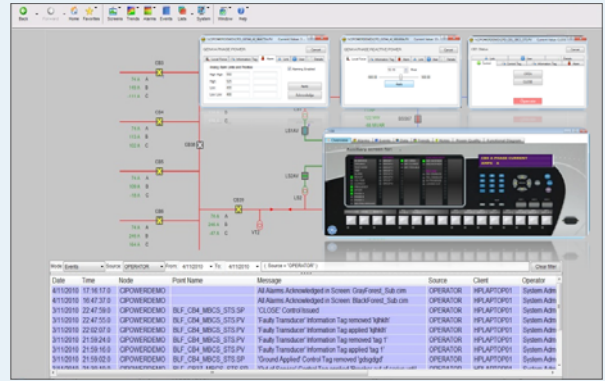

Real time data acquisition & control

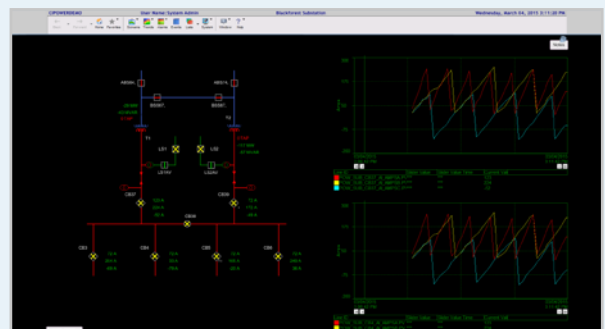

One-line screens for monitoring status, control and tagging



Tab Displays provide centralized, consistent control interfaces for substation equipment and IEDs

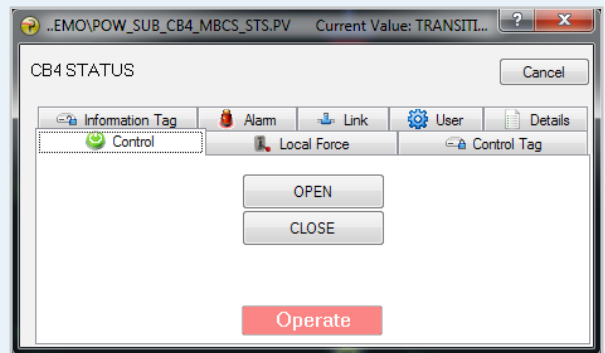

Operator Dialogs enable controls such as disabling alarms and opening or closing circuit breakers

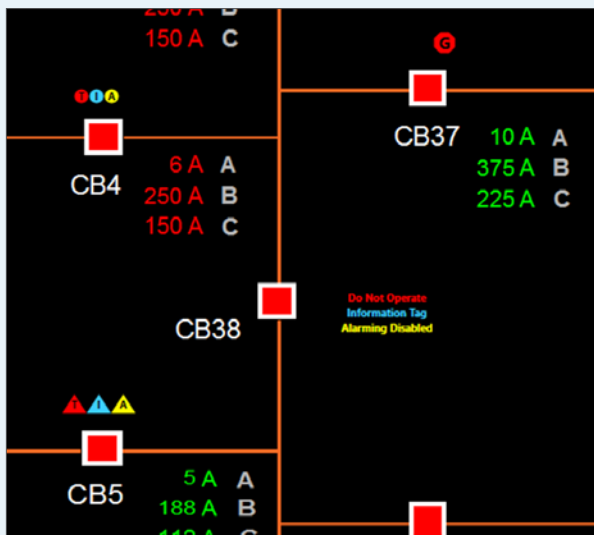

Attributes provide clear indicators of equipment conditions

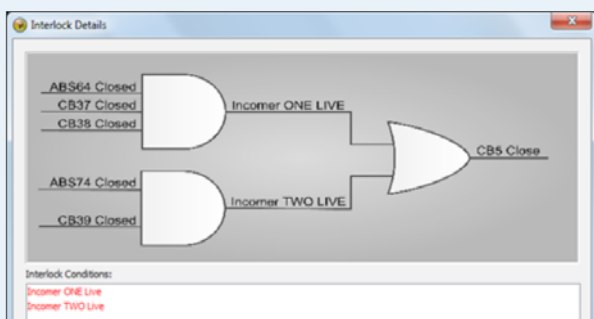

Intuitive Interlocking logic control diagrams

| Msg | Priority | Location | Point Name | Message | End State | Current State | Date Last | Time Last | Device | Current Value | Date |
|----------|----------|------------------|-----------------------|---------|-----------|---------------|--------------|-----------|----------|---------------|------|
| LOW | BLF | BLF_BSS07_CV_STS | BUS SECTION SWITCH 07 | CFM | OK | 20140820 | 15:57:48.001 | 05067 | OPEN | 2014 | |
| HIGH | LOL | BLF_CB37_A_CUR | CB37 A PHASE | LO | LO | 20140820 | 15:57:21.129 | CB33 | 0.00 | 2014 | |
| MECKM | BLF | BLF_CB37_A_KIB | KV PHASE A | LO | LO | 20140820 | 15:57:21.129 | CB33 | 0.00 | 2014 | |
| MECKM | BLF | BLF_CB37_B_KIB | KV PHASE B | LO | LO | 20140820 | 15:57:21.129 | CB33 | 0.00 | 2014 | |
| MECKM | BLF | BLF_CB37_C_KIB | KV PHASE C | LO | LO | 20140820 | 15:57:21.129 | CB33 | 0.00 | 2014 | |
| LOW | BLF | BLF_CB37_A_AMP | CB37 A PHASE CURRENT | RATE | RATE | 20140820 | 16:02:22.079 | CB37 | 245.4 | 2014 | |
| MECKM | BLF | BLF_CB37_B_AMP | CB37 B PHASE CURRENT | H | RATE | 20140820 | 16:02:22.079 | CB37 | 395.4 | 2014 | |
| LOW | BLF | BLF_CB37_C_AMP | CB37 C PHASE CURRENT | RATE | RATE | 20140820 | 16:02:22.079 | CB37 | 5.4 | 2014 | |
| LOW | BLF | BLF_CB37_A_MNR | CB37 MNR | H | H | 20140820 | 16:02:22.079 | CB37 | 11.8 MNR | 2014 | |
| LOW | BLF | BLF_CB37_B_MNR | CB37 MNR | LO | LO | 20140820 | 16:02:22.079 | CB37 | 11.8 MNR | 2014 | |
| CRITICAL | BLF | BLF_CB37_A_VOL | CB37 A PHASE VOLTAGE | CFM | CFM | 20140820 | 15:57:21.129 | CB33 | 16.8 kV | 2014 | |
| LOW | BLF | BLF_CB39_A_AMP | CB39 A PHASE CURRENT | RATE | RATE | 20140820 | 16:02:22.079 | CB39 | 245.4 | 2014 | |
| MECKM | BLF | BLF_CB39_B_AMP | CB39 B PHASE CURRENT | H | RATE | 20140820 | 16:02:22.079 | CB39 | 395.4 | 2014 | |
| LOW | BLF | BLF_CB39_C_AMP | CB39 C PHASE CURRENT | RATE | RATE | 20140820 | 16:02:22.079 | CB39 | 5.4 | 2014 | |
| LOW | BLF | BLF_CB39_A_MNR | CB39 MNR | LO | LO | 20140820 | 16:01:23.099 | CB39 | 2.2 MNR | 2014 | |
| LOW | BLF | BLF_CB39_B_MNR | CB39 MNR | LO | LO | 20140820 | 16:02:22.079 | CB39 | 4.7 MNR | 2014 | |
| HIGH | BLF | BLF_CB39_A_VOL | CB39 A PHASE VOLTAGE | LO | LO | 20140820 | 15:57:21.129 | CB33 | 16.8 kV | 2014 | |
| HIGH | BLF | BLF_CB39_B_VOL | CB39 B PHASE VOLTAGE | H | H | 20140820 | 15:58:41.077 | CB39 | 13.2 kV | 2014 | |
| HIGH | BLF | BLF_CB39_C_VOL | CB39 C PHASE VOLTAGE | LO | LO | 20140820 | 15:59:26.009 | CB39 | 18.1 kV | 2014 | |
| CRITICAL | BLF | BLF_CB39_A_VOL | CB39 A PHASE VOLTAGE | CFM | CFM | 20140820 | 16:02:21.988 | CB39 | 16.8 kV | 2014 | |
| HIGH | BLF | BLF_CB37_A_AMP | CB37 A PHASE CURRENT | H | H | 20140820 | 15:58:20.054 | CB37 | 163.4 | 2014 | |
| HIGH | BLF | BLF_CB37_B_AMP | CB37 B PHASE CURRENT | H | H | 20140820 | 15:57:21.129 | CB37 | 395.4 | 2014 | |
| HIGH | BLF | BLF_CB37_C_AMP | CB37 C PHASE CURRENT | H | H | 20140820 | 16:03:56.068 | CB37 | 3.4 | 2014 | |
| HIGH | BLF | BLF_CB37_A_KIB | KV PHASE A | LO | LO | 20140820 | 15:57:21.129 | CB33 | 0.00 | 2014 | |
| MECKM | BLF | BLF_CB37_B_KIB | KV PHASE B | LO | LO | 20140820 | 15:57:21.129 | CB33 | 0.00 | 2014 | |
| MECKM | BLF | BLF_CB37_C_KIB | KV PHASE C | LO | LO | 20140820 | 15:57:21.129 | CB33 | 0.00 | 2014 | |

Alarms List increases operator awareness, decreases response time and improves system reliability

Standard Lists and Reports

- Alarms
- Events
- Sequence of Events
- Off-Normal
- Dynamic database display
- Control tag
- Information tag
- Local Force
- Off-Scan
- Disabled alarms
- Operator notes

Equipment Attributes

Attributes provide easy to understand, high-visibility indicators for equipment conditions. They are informative graphical cues that can be designed and configured to meet your operational preferences. Attributes can indicate the presence of control tags, information tags, off scan, local force applications or disabled alarms.

Safe Operations

PowerLink Connect features a range of comprehensive safety features and functions:

- Select before operate control
- Control timeout; control fail alarm
- Simultaneous control lockout
- Control tagging (control lockout)
- Information tagging
- Equipment "Attribute" indicators

Control Interlocking

PowerLink Connect provides powerful logic-based control lockouts to prevent equipment operations when specific conditions are not met. Interlocking can be used to prevent harm to personnel on site when working on equipment by preventing operators from erroneously issuing controls in undesirable situations. It also protects electrical hardware by ensuring it is not subject to undesirable electrical loads. Interlocking includes graphical logic diagrams to illustrate why operations are blocked and what steps are not aligned to enable operation.

Alarm Management

Central to the role of the operator is quickly identifying and addressing exception conditions within the system. PowerLink Connect provides a multitude of alarm notification and management functionality to increase operator awareness, decrease response time and improve system reliability.

- Visual and audible notification
- Historical logging
- Millisecond resolution time stamping
- Group, area and priority categories
- Advanced filtering and sorting

Events List

The Event List is a comprehensive and permanent record of management activity including:

- A permanent, searchable, chronological record of operator actions and activity
- Advanced filtering
- Quick filtering on location and device
- Display historical events from any period
- High resolution sequence of events with millisecond accuracy to determine the exact sequence that critical changes have occurred
- Operators can record comments about events
- Operators can enter messages into events
- Auditing of operator actions for security and accountability

Secure Control

PowerLink Connect provides enhanced security options and configurable user and group role-based security. Security configuration allows access and operational permissions to be set for individual users and for user groups. Furthermore, PowerLink Connect has an operator access and change log to audit operations and aid in security reporting.

Open and Connected Communications

PowerLink Connect enables you to leverage your existing investments as well as future proofing the new devices you may choose tomorrow. With support for hundreds of drivers off-the-shelf, including, DNP 3.0, IEC 61850 and many others; and full OPC client and server support, PowerLink Connect is a truly open, vendor-independent solution that's flexible and interoperable – translating into real value.

- Proven communications software for multiple of brands of RTUs, IEDs, PLCs and other I/O devices
- Industry standard communications protocol compatibility for DNP 3.0, IEC 870-5-101, 870-5-104, IEC 61850
- Full OPC server and client support
- Multiple simultaneous serial and/or Ethernet communications channels
- VisiconX SQL wizard

PowerLink Connect provides a complete, scalable, feature rich, secure solution to optimize resource efficiency and ensure reliability.

PowerLink Connect can be installed as a stand-alone system (a single computer providing all functions) or with redundant server systems:

- Server functions such as real-time communication with IEDs and RTUs, database management, alarm and event management and historical recording including sequence of events (SOE).
- Client functions such as operator and/or engineering HMI, including monitoring, control and configuration.

Technical Services

From initial Site Evaluation to ongoing maintenance of the system, the GE Digital Energy projects team provides services for the complete lifecycle of a solution.

- Site Evaluation
- Consultation
- System Design
- Project Management
- Procurement
- System component assembly
- Configuration and Commissioning Services
- System Testing
- Training
- Lifecycle Support of System

Infrastructure Improvements

- System planning/design
- Power delivery equipment & systems
- Turnkey delivery

Connectivity

- Enables visualization of assets
- Power system reconfiguration
- Communications enabling AMI

Reliability & Optimization

- Self-healing power systems
- Network/asset planning & management systems
- Substation & feeder automation
- Equipment monitoring & diagnostics

Safety & Security

- Personnel & public safety
- Availability of electrical assets
- Cyber security & private networks

Workforce Automation

- Outage managements systems
- Mobile workforce solutions
- Remote monitoring & diagnostics

Single Computer Architecture

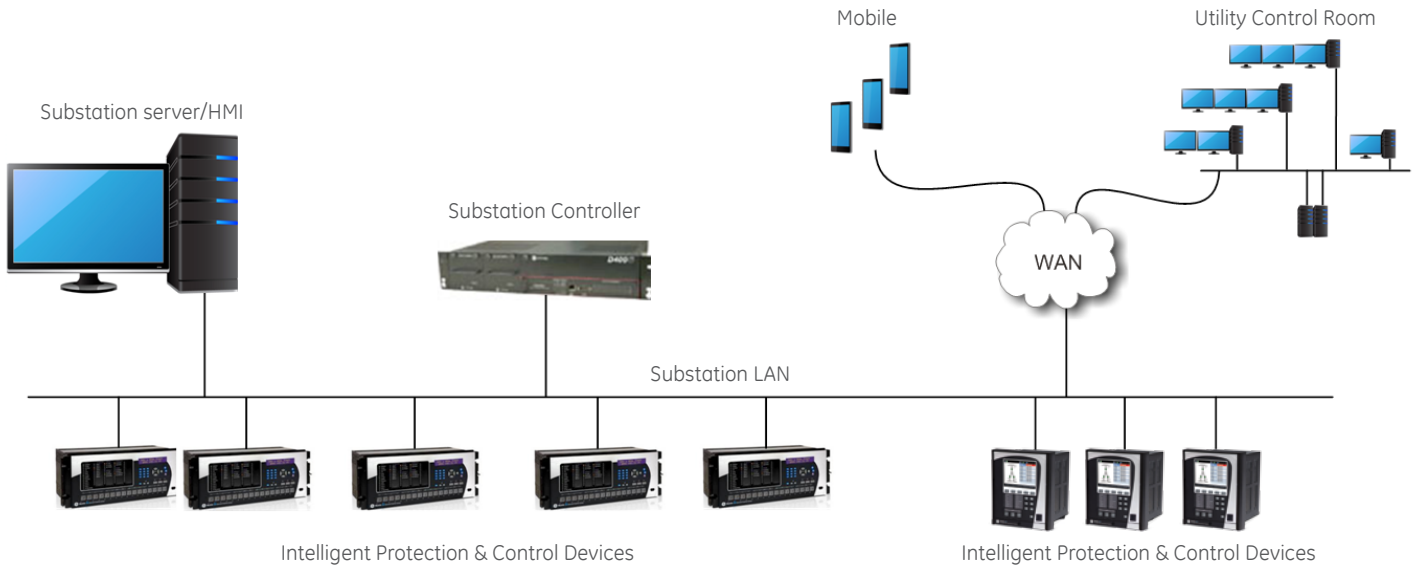

Redundant Multi-Server Architecture

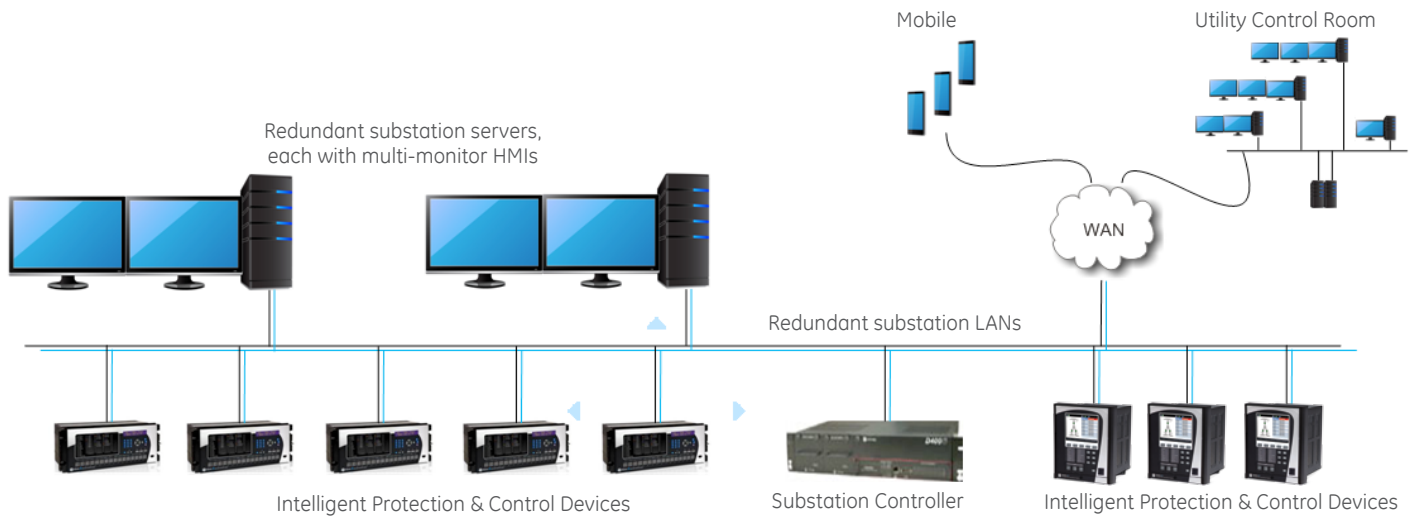

PowerLink Connect supports server redundancy to ensure high availability.

System Requirements

| Requirement | Specification |
|-----------------------------|--|
| Supported Operating Systems | Note: Machines can be 32-bit or 64-bit Microsoft® Windows® Server 2012 R2 Microsoft® Windows® Server 2012 Microsoft® Windows® Server 2008 SP2 R2 Microsoft® Windows® 8.1 Microsoft® Windows® 8 Microsoft® Windows® 7 SP1 |
| Computer & Processor | CPU: Intel® Core 2 Duo 3.0 GHz (minimum) Installation: DVD drive |
| Memory | RAM: 4 GB (minimum) |
| Hard Disk | HDD: 40 GB (minimum) |
| Display | SVGA or better color graphics monitor, 24-bit graphics card capable of 800x600 resolution (minimum) |
| Connectivity | One free direct-connect USB port (for license keys) Some touch screens, pointing devices, and I/O drivers require a serial port Additional ports for I/O hardware. |

Note: Actual system requirements also depend on what features are included beyond the base system (e.g. whether or not data logging is enabled, application size). Therefore, it is strongly recommended that you test your particular system for performance needs to determine what hardware is appropriate above the base system recommendations.

PowerLink Connect At-a-Glance

| Solution | Description Key Features | Outcomes Key Benefits |
|--------------------------------------|---|--|
| Real-Time Equipment Monitoring | <ul style="list-style-type: none"> Real-time, dynamic data collection and display (one-line / 3D graphics) Unlimited device connections & communication Supports: meters / PLC / generators / PDU / trip units & more Monitors: RMS current & voltage / KW & KWh / events / alarms & more Widescreen, multi-monitor support, mobile device and Web-enabled operator interfaces Secure, supervisory control of devices & operations Prioritized alarms, precision sequence of events, centralized monitoring of operations Vendor agnostic equipment support; works with anything Redundant system architecture ensures reliable operations Wide range of supported device communication protocols, including: BacNet, Modbus, IEC 61850, DNP3 | <ul style="list-style-type: none"> Secure oversight of facility operations & energy usage High availability, reliable services Scalability to add equipment as required without additional costs, & freedom to choose your preferred supplier Flexibility to monitor & control operations from anywhere Proven solution backed by industry-leading support and consulting services for dependable peace-of-mind Easy-to-use, familiar and intuitive operator interfaces enhance efficiency and improve day-to-day operations Active, ongoing system development ensures future-proof operations and real return on investment (ROI) |
| Mobile Device & Web-Based Operations | <ul style="list-style-type: none"> Realtime operational intelligence (RtOI) accessible anytime, anywhere Secure operator login access from any location via any Web-enabled mobile device | <ul style="list-style-type: none"> Place key information in the right hands at the right time Enhance decision making and improve operations Access operational data from anywhere and with any device, enable greater freedom and flexibility for operations |

PowerLink Connect At-a-Glance (Cont'd)

| Solution | Description Key Features | Outcomes Key Benefits |
|-------------------------------------|--|---|
| Big Data Energy Analysis & Trending | <ul style="list-style-type: none"> High performance, 'Big Data' archiving and reporting solution Collection, archival and storage of large volumes of data from multiple sources into workable database structures Collation and formatting of disparate data structures into a single framework - turns big data volumes into meaningful, actionable information | <ul style="list-style-type: none"> Delivers meaningful context for vast amounts of raw data from across your operations Aggregates islands of information for true process visibility and feeds higher-level operations management systems with accurate, real-time information Enterprise performance & scalability |
| Intelligent Process Automation | <ul style="list-style-type: none"> Automated control of devices and services Open/close breakers Intelligent load management Automated shutdown or startup processes Specialist GE consulting and development services to customize automations processes | <ul style="list-style-type: none"> High availability services with near-zero downtime Streamlined operations in complex environments Millisecond response to 'off-normal' situations with prescribed automatic procedures Optimal operations efficiency, sustainable competitive advantage, improved return on investment and advanced cost savings |

GlobalCare Customer Support

Tailored support services to help you quickly resolve issues – maximizing operational availability and productivity, while minimizing risk.

24x7 Emergency Support

Rely on emergency service around-the-clock with our comprehensive infrastructure of phone and web-based support. Our support professionals provide the highest level of expertise for your emergency, no matter what time of day or where your operations are located.

Free Product Upgrades and Maintenance

Keep pace with operating system advances and stay abreast with the latest technology innovations and features for your PowerLink Connect & Proficy products with free software version upgrades, to help optimize your investment.

Multi-lingual Support

Offering support in 10 languages including: English, French, German, Spanish, Chinese, Czech, Italian, Japanese (primary languages of support); also Dutch and Slovak

Benefits of GE's GlobalCare Support

| | | WHAT'S INCLUDED |
|------------------------|--|-----------------|
| Software Modernization | No Charge Software Version Upgrades | ✓ |
| Technical Support | Global Network of Support Professionals | ✓ |
| | Phone and Web Consultation during Standard Business Hours | ✓ |
| | 24 x 7 Emergency Support | ✓ |
| Software Maintenance | Service Packs | ✓ |
| | Developer & Productivity Downloads | ✓ |
| GlobalCare exclusives | Free Test Bed Keys (expiration aligned with GlobalCare end date) | ✓ |
| | No Key Administration Fees | ✓ |

Ordering Code

| PLH | Version | Type | Points | Drivers | Server Add-ins | Add-ins(1) | Add-ins(2) | Add-ins(3) | Add-ins(4) | Viewer | License Key | Global Support Care | Description |
|-------------------------------------|---------|------|--------|---------|----------------|------------|------------|------------|------------|--------|-------------|---------------------|---|
| | A | S | DR05 | D05 | XXX | X | X | X | XXXX | XX | H | 1 | Uses Cimplicity v9.0 rev 2 |
| License Type | | S | | | | | | | | | | | Development Server License |
| | | V | | | | | | | | | | | Runtime Viewer License |
| Points for Server | | | DR05 | | | | | | | | | | Server Development & Runtime System - 5,000 Points |
| | | | DR10 | | | | | | | | | | Server Development & Runtime System - 10,000 Points |
| | | | DR35 | | | | | | | | | | Server Development & Runtime System - 35,000 Points |
| | | | DRUL | | | | | | | | | | Server Development & Runtime System - Unlimited Points |
| | | | RO05 | | | | | | | | | | Server Runtime Only System - 5,000 Points |
| | | | RO10 | | | | | | | | | | Server Runtime Only System - 10,000 Points |
| | | | RO35 | | | | | | | | | | Server Runtime Only System - 35,000 Points |
| | | | ROUL | | | | | | | | | | Server Runtime Only System - Unlimited Points |
| | | | XXXX | | | | | | | | | | Not Applicable (for viewer Licenses) |
| Drivers | | | | D05 | | | | | | | | | DNP3, 5,000 Points |
| | | | | D10 | | | | | | | | | DNP3, 10,000 Points |
| | | | | D35 | | | | | | | | | DNP3, 35,000 Points |
| | | | | DUL | | | | | | | | | DNP3, Unlimited |
| | | | | I05 | | | | | | | | | IEC 61850, 5,000 Points |
| | | | | I10 | | | | | | | | | IEC 61850, 10,000 Points |
| | | | | I35 | | | | | | | | | IEC 61850, 35,000 Points |
| | | | | IUL | | | | | | | | | IEC 61850, Unlimited |
| | | | | XXX | | | | | | | | | Applicable for Viewer License |
| Remote-client add-in for the Server | | | | | W01 | | | | | | | | CIMPPLICITY Webspace - 1 Concurrent user |
| | | | | | T01 | | | | | | | | CIMPPLICITY HMI Terminal Services 1 User |
| | | | | | T05 | | | | | | | | CIMPPLICITY HMI Terminal Services 5 User |
| | | | | | T10 | | | | | | | | CIMPPLICITY HMI Terminal Services 10 User |
| | | | | | XXX | | | | | | | | Not Applicable |
| Redundancy | | | | | | R | | | | | | | Cimplicity HMI Host Redundancy |
| | | | | | | X | | | | | | | Not Applicable |
| System Sentry | | | | | | | S | | | | | | Cimplicity System Sentry (1 Node) |
| | | | | | | | X | | | | | | Not Applicable |
| Alarm Cast Standard | | | | | | | | A | | | | | Cimplicity Alarm Cast Standard |
| | | | | | | | | X | | | | | Not Applicable |
| SQL Server | | | | | | | | | SQ05 | | | | Standard SQL Server - 5 user |
| | | | | | | | | | SQ10 | | | | Standard SQL Server - 10 user |
| | | | | | | | | | XXXX | | | | Use SQL Express as default. Do not need Standard SQL Server |
| Viewer Options | | | | | | | | | | DV | | | CIMPPLICITY HMI Viewer Development & Runtime System |
| | | | | | | | | | | RV | | | CIMPPLICITY HMI Viewer Runtime System |
| | | | | | | | | | | XX | | | Not Applicable |
| License Type | | | | | | | | | | | H | | USB Security Key [Hardware] |
| GlobalCare Support | | | | | | | | | | | | 1 | 1 year GlobalCare Support |
| | | | | | | | | | | | | 2 | 2 year GlobalCare Support |
| | | | | | | | | | | | | 3 | 3 year GlobalCare Support |

GE Digital Energy

650 Markland St. Markham, ON
Canada L6C 0M1

GEDigitalEnergy.com

Microsoft and Windows are registered trademarks of Microsoft.

GE, the GE monogram and PowerLink are trademarks of General Electric Company.

GE reserves the right to make changes to specifications of products described at any time without notice and without obligation to notify any person of such changes.

Copyright 2015, General Electric Company. All Rights Reserved.



imagination at work

GEA-12927A(E)
English
151013