



# Multilin UR & UR<sup>Plus</sup>

## Proven, State-of-the-Art Protection & Control Systems

From the power plant to the power consumer, the Multilin™ UR & UR<sup>Plus</sup> family of advanced protection and control relays provides one integrated platform that delivers leading edge protection, control, monitoring & metering solutions for critical power system applications. Featuring proven protection algorithms, expandable I/O, integrated monitoring & high accuracy metering capabilities with the latest in communications technologies, the Multilin UR & UR<sup>Plus</sup> family of devices provides the situational awareness needed for a reliable, secure and efficient modern grid.

### Key Benefits

- Modular construction: common hardware, reduced stock of spare parts, plug & play modules for maintenance cost savings and simplification (Multilin UR)
- Proven flexibility and customization capabilities make the Multilin UR/UR<sup>Plus</sup> devices suitable to retrofit almost any kind of legacy P&C scheme
- Large HMI and annunciator panels provide local monitoring & control capabilities, and backup the substation HMI
- Phase measurement Unit (synchrophasors) according to IEEE® C37.118 (2011) and IEC® 61850-90-5 directly streamed from your protective device
- Embedded IEEE 1588 Time Synchronization Protocol support eliminates dedicated IRIG-B wiring requirements for P&C devices (Multilin UR)
- Advanced IEC 61850 Ed. 1 and Ed. 2 certified implementation, complete settings via SCL files and comprehensive process bus support (IEC 61850-9-2LE or IEC 61869 or IEC 61850-9-2 Hardfiber) ensures interoperability, device managing optimization and reduced cost of ownership
- Routable GOOSE (R-GOOSE) enables customer to send GOOSE messages beyond the substation, which enables WAPC and more cost effective communication architectures for wide area applications
- Increased network availability via failover time reduced to zero through IEC® 62439-3 "PRP" support
- Supports IEEE C37.111-1999/2013, IEC 60255-24 Ed 2.0 COMTRADE standard

### Applications

- Protection, control, monitoring and supervision of power assets across generation, transmission, distribution, substation and industrial systems
- Utility substation and industrial plant automation
- Digital fault recording and Sequence of Event (SOE) recording
- Predictive maintenance through data analysis and trending
- Synchrophasors based monitoring and control system with specialized PMU devices that support multiple feeders providing P&M class synchrophasors of voltage, current, and sequence components
- Complex protection & control and wide area monitoring solutions with complete diagnostic and automation capabilities (Multilin UR<sup>Plus</sup>)

## Protection and Control

- Fast, segregated line current differential & distance protection functionality in one device
- Phase distance (5 zones) with independent settings for compensation
- Single-pole tripping, breaker-and-a-half with independent current source support
- Comprehensive generator protection with 100% stator and field ground fault detection
- Protection and control functionality in one box, reducing the number of devices
- Integrated large, full color display, for real-time visualization and control of the protected bay

## Advanced Communications

- 3 independent Ethernet ports for simultaneous & dedicated network connections with IEEE 1588 support
- IEC 61850-9-2LE/IEC 61869 networked or IEC61850-9-2 Hardfiber process bus support

## Cyber Security

- CyberSentry™ provides high-end cyber security aligned to industry standards and services (NERC® CIP, AAA, Radius, RBAC, Syslog)

## Monitoring & Metering

- Advanced recording capabilities, configurable & extended waveform capture and data logger
- Fault locator fault reports & programmable
- Breaker condition monitoring including breaker arcing current (I<sub>2t</sub>), breaker re-strike and breaker flashover
- Metering: current, voltage, power factor, frequency, voltage & current harmonics, energy, demand, phasors, etc.

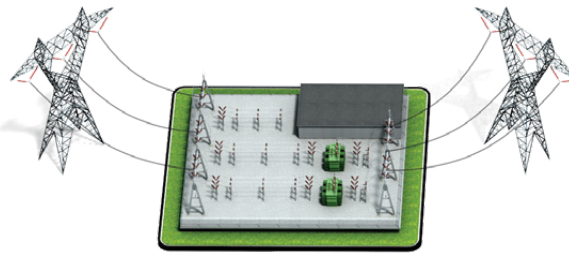

UR & UR<sup>Plus</sup> Market Offerings

## Generation

**G60**

Medium to Large Generators

The G60 provides comprehensive primary and backup protection for medium and large generators, including large steam and combustion turbines, combined-cycle generators and multi-circuit hydro units. The G60 includes advanced automation and communication capabilities, extensive I/O options, and powerful fault recording features that simplify postmortem analysis and minimize generator downtime.

**G30**

Combined Generator & Transformer Protection

The G30 is a flexible system that can be used on small and medium generators, generator and step-up transformer arrangements or backup protection of large generators. Similar to the G60, the G30 also offers comprehensive protection and monitoring elements.

## Transmission &amp; Distribution

**D90<sup>Plus</sup>**

Sub-Cycle Distance Protection

The D90<sup>Plus</sup> is ideally suited for application on transmission lines where fast fault detection and small breaker failure margin are required. The D90<sup>Plus</sup> allows transmission limits to be maintained or even increased while respecting the transient stability limits of the power system.

**D60**

Fully Featured Distance Protection

The D60 is the ideal solution for providing reliable and secure primary and backup protection of transmission lines supporting: series compensation, teleprotection schemes, five mho or quad distance zones, single or three-pole tripping, breaker-and-half with independent current inputs, phasor measurement units (PMUs), and more.

**D30**

Backup Distance Protection

The D30 is the cost-effective choice for the primary protection of sub-transmission systems or backup protection of transmission systems. Using FlexLogic™ elements, basic pilot schemes can be programmed. The D30 has complementary protection, control, communication, monitoring and metering functions that meet the toughest requirements of the market.

**L90**

Complete Line Protection

The L90 is a fast and powerful high-end phase-segregated line current differential and complete distance protection system, suitable for MV cables, two or three terminal transmission lines having breaker-and-half and single or three-pole tripping schemes.

**L60**

Line Phase Comparison Protection

The L60 is an extremely fast line phase comparison system, suitable for two or three terminal transmission lines. This system is able to operate using power line carrier or fiber optic communications.

**L30**

Sub-Transmission Line Current Differential Protection

The L30 is a cost-effective phase-segregated line current differential system intended to provide primary protection for MV cables and two/three-terminal sub-transmission lines or backup protection to transmission lines.

**B90**

Centralized or Distributed Busbar Prot

The B90 is an advanced low-impedance differential protection system that is intended to cover applications ranging from small to large substations, having either single or complex-split busbar schemes. It is able to support busbars with up to 24 breakers, and 4 single phase differential zones.

**B30**

Centralized or Distributed Busbar Prot

The B30 is a cost-effective, advanced protection system that fits busbars with up to 6 circuits and two zones (centralized schemes) or 16 circuits and six zones (distributed schemes). The B30 provides advanced elements like CT trouble, directional and CT saturation, breaker failure and voltage supervision that make the B30 an extremely fast and secure busbar protection system. B30 also fits conventional centralized or process bus based distributed bus bar protectionschemes.

**B95<sup>Plus</sup>**

Distributed Busbar Protection System

The B95<sup>Plus</sup> is GE's distributed busbar solution that can be applied to any kind of busbar configuration and uses standard IEC 61850 protocol to connect to the bay units. The B95<sup>Plus</sup> delivers comprehensive and reliable protection for busbar applications with up to 24 feeders.

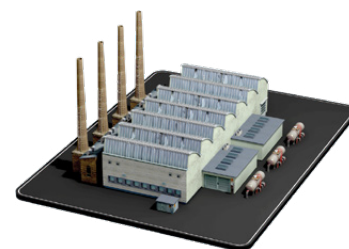

## Transmission & Distribution (Continued)

### F60

#### Feeder Protection with Hi-Z Fault Detection

The F60 provides comprehensive feeder protection, control, advanced communications, monitoring and metering in an integrated, economical, and compact package and more.

### F35

#### Multiple Feeder Protection

The F35 is a cost-effective device for primary feeder protection. F35's modular design allows customers to protect groups of feeders as follows: independent current and voltage inputs, independent current and common voltage inputs or independent current inputs only.

### C70

#### Capacitor Bank Protection

The C70 is an integrated protection, control, and monitoring device for shunt capacitor banks. The current and voltage-based protection functions are designed to provide sensitive protection for grounded, ungrounded single and parallel capacitor banks and banks with taps.

### T60

#### Medium to Large Transformers

The T60 is a fully featured transformer protection system suitable for power transformers of any size that require current differential function. The T60 provides automatic or user-definable magnitude reference winding selection for CT ratio matching, and performs automatic phase shift compensation for all types of transformer winding connections.

### T35

#### Basic Transformer Protection, Multiple CTs

The T35 is a basic transformer protection system capable of protecting combined main power transformers and up to five feeders downstream. The T35 provides automatic or user-definable magnitude reference winding selection for CT ratio matching, automatic phase shift compensation and allows users to enable removal of the zero-sequence current even for delta connected transformer windings.

### C90<sup>Plus</sup>

#### Breaker Automation and Controller

The C90<sup>Plus</sup> is a powerful logic controller designed to be used in substation environments and for the unique automation requirements of industrial and utility power systems. The C90<sup>Plus</sup> provides unmatched logic processing ability combined with a powerful math engine with deterministic execution of logic equations regardless of the configuration of the number of lines of logic.

### C60

#### Breaker Controller

The C60 is a substation hardened controller that provides a complete integrated package for the protection, control, and monitoring of circuit breakers, supporting dual-breaker busbar configurations, such as breaker-and-half or ring bus schemes.

### C30

#### I/O Logic Controller

The C30 is designed to perform substation control logic that can also expand the I/O capability of protection devices and replace existing Sequence of Events (SOE) recorders.

### M60

#### Motor Protection

The M60 offers comprehensive protection and control solutions for large-sized three-phase motors. The M60 provides superior protection, control, and diagnostics that includes thermal model with RTD and current unbalance biasing, stator differential, reverse and low forward power, external RRTD module, two-speed motors, reduced voltage starting, broken rotor bar detection, and more.

### N60

#### Network Stability and Synchrophasor Measurement

The N60 is intended to be used on load shedding, remedial action, special protection and wide area monitoring and control schemes. Like no one device before, the N60 shares real-time operational data to remote N60s so the system can generate intelligent decisions to maintain power system operation.

## Overview

The Universal Relay (UR) is a family of leading edge protection and control products built on a common modular platform. All UR products feature high-performance protection, expandable I/O options, integrated monitoring and metering, high-speed communications, and extensive programming and configuration capabilities. The UR forms the basis of simplified power management for the protection of critical assets, either as a stand-alone device or within an overall power automation system.

The UR is managed and programmed through EnerVista Launchpad. This powerful software package, which is included with each relay, not only allows the setpoints of the relay to be programmed, but also provides the capability to manage setpoint files, automatically access the latest versions of firmware/documentation and provide a window into the substation automation system.

The UR can be supplied in a variety of configurations and is available as a 19-inch rack horizontal mount unit or a reduced size (¾) vertical mount unit. The UR consists of the following modules: power supply, CPU, CT/VT input, digital input/output, transducer input/output, inter-relay communications, communication switch and IEC 61850 Process Bus. All hardware modules and software options can be specified at the time of ordering.

## Protection and Control

The UR incorporates the most complete and unique protection algorithms to provide unparalleled security and system uptime. The UR selector guide (in the following pages) lists all the protection elements found in each relay.

To support the protection and control functions of the UR, various types and forms of I/O are available (specific capabilities are model dependent). Supported I/Os include:

### CTs and VTs

Up to 24 analog current transformer (CT) and voltage transformer (VT) signals can be configured to monitor AC power lines. Both 1 A and 5 A CTs are supported. Special function modules are available including: a CT module with sensitive ground input to provide ground fault protection on high-impedance grounded systems, and a high-impedance fault detection module that provides fast and reliable detection of faults caused by downed conductors.

## UR - Protection, Metering, Monitoring and Control

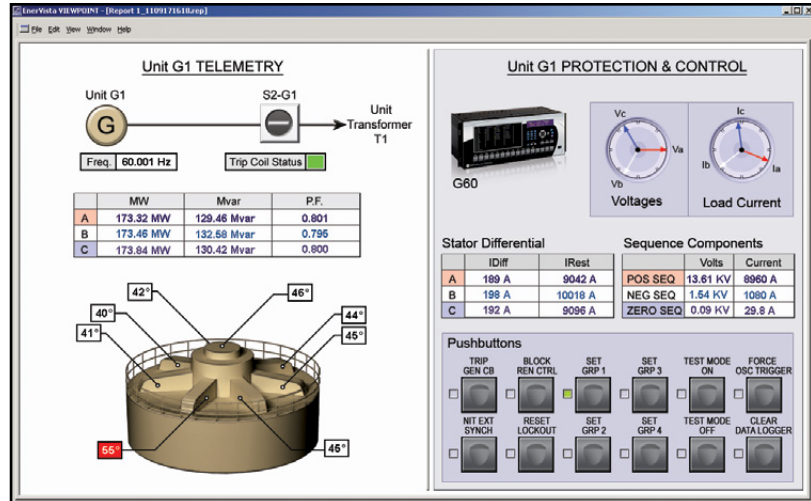

The UR is the single point for protection, control, metering, and monitoring in one integrated device that can easily be connected directly into DCS or SCADA monitoring and control systems like Viewpoint Monitoring as shown.

### Digital I/O

Up to 120 contact inputs (with utility voltage rating up to 250V), and up to 72 contact outputs, are available and can be used to monitor and control a wide range of auxiliary equipment found within a substation or other protection application. Types of digital I/O cards include trip-rated Form-A, Form-C, Fast Form-C, latching and Solid State Relay (SSR), with or without DC voltage, current monitoring and isolated inputs (with auto burnish feature). Mechanically latching outputs can be used to develop secure interlocking applications and replace mechanical switches and lockout relays. Form-A digital outputs have activation speeds of less than 4ms and both wet and dry contacts are supported.

Solid state output modules with high current breaking capability, fast tripping and reset time are ideal for direct tripping applications.

### Transducer I/O

RTDs and DCmA cards are available to monitor system parameters, such as temperature, vibration, pressure, wind speed, and flow. Analog outputs can be used for hardwired connections from the controller to a SCADA system, to a programmable logic controller (PLC), or to other user interface devices (eg. panel display).

## Advanced Automation

The UR incorporates advanced automation features including powerful FlexLogic programmable logic, communication, and SCADA capabilities that far surpass what is found

in the average protection relay. Each UR can be seamlessly integrated with other UR relays for complete system protection and control.

### FlexLogic

FlexLogic is the powerful UR-platform programming logic engine that provides the ability to create customized protection and control schemes, minimizing the need and associated costs of, auxiliary components and wiring. With 1024 lines of FlexLogic, the UR can be programmed to provide the required tripping logic along with custom scheme logic for breaker control (including interlocking with external synchronizers), transfer tripping schemes for remote breakers and dynamic setting group changes.

### Scalable Hardware

The UR is available with a multitude of I/O configurations to suit the most demanding application needs. The expandable modular design allows for easy configuration and future upgrades.

- Multiple CT/VT configurations allow for the implementation of many different schemes, including concurrent split-phase and differential protection
- Flexible, modular high density I/O covering a broad range of input signals and tripping schemes with trip rated Form-A for high density outputs and Trip rated Form A, SSR, Form-C and mechanically latched relays for normal outputs
- Inter-relay communications module that enables the sharing of digital status and analog values between UR relays for control, fast tripping or teleprotection applications



| DFR – SUMMARY                                                                                                                       |                                  |                                    |           |             |               |           |             |
|-------------------------------------------------------------------------------------------------------------------------------------|----------------------------------|------------------------------------|-----------|-------------|---------------|-----------|-------------|
|                                                                                                                                     | Ready to Capture                 | Memory Available                   |           |             |               |           |             |
| Fault Report                                                                                                                        | <span style="color:red">●</span> | <span style="color:green">●</span> |           |             |               |           |             |
| Transient Recorder                                                                                                                  | <span style="color:red">●</span> | <span style="color:green">●</span> |           |             |               |           |             |
| Disturbance Recorder                                                                                                                | <span style="color:red">●</span> | <span style="color:green">●</span> |           |             |               |           |             |
| Records                                                                                                                             | Latest                           | Total                              |           |             |               |           |             |
| Events                                                                                                                              | Mar 05 2009 12:23:23:637727      | 431                                |           |             |               |           |             |
| Faults                                                                                                                              | Mar 05 2009 12:23:20:735543      | 1                                  |           |             |               |           |             |
| Transients                                                                                                                          | Mar 05 2009 12:23:20:721634      | 1                                  |           |             |               |           |             |
| Disturbances                                                                                                                        | Mar 04 2009 02:47:12:346789      | 3                                  |           |             |               |           |             |
| <table border="1"> <tr> <td>Summary</td> <td>SOE</td> <td>Fault Reports</td> <td>Transient</td> <td>Disturbance</td> </tr> </table> |                                  |                                    | Summary   | SOE         | Fault Reports | Transient | Disturbance |
| Summary                                                                                                                             | SOE                              | Fault Reports                      | Transient | Disturbance |               |           |             |

Digital fault recorder summary with the latest information on the events, faults, transients and disturbances.

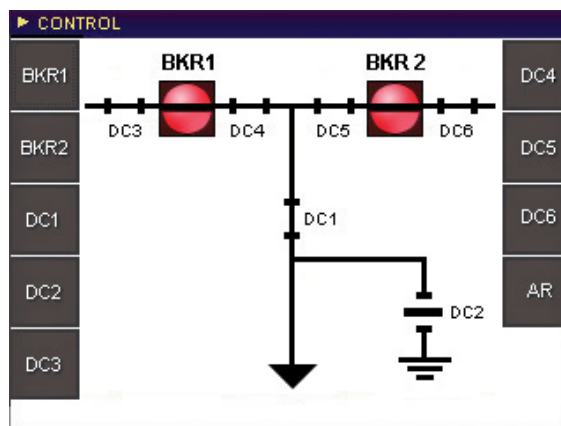

Control screen for the preconfigured bay with breaker & disconnect control in multiple pages using dedicated pushbuttons in the front panel.

- Types of digital outputs include trip-rated Form-A and SSR mechanically latching, and Form-C outputs
- Form-A and SSR outputs available with optional circuit continuity monitoring and current detection to verify continuity and health of the associated circuitry
- IEC 61850 Process Bus delivering advanced protection and control capabilities while providing significant savings on the total life cost of electrical substations
- RTDs and DCmA inputs are available to monitor equipment parameters such as temperature and pressure

## Monitoring and Metering

The UR includes high accuracy metering and recording for all AC signals. Voltage, current, and power metering are built into the relay as a standard feature. Current and voltage parameters are available as total RMS magnitude, and as fundamental frequency magnitude and angle.

### Fault and Disturbance Recording

The advanced disturbance and event recording features within the UR can significantly reduce the time needed for postmortem analysis of power system events and the creation of regulatory reports. Recording functions include:

- Sequence of Event (SOE)
  - 1024 time stamped events (UR Relays)
  - 8192 time stamped events (URPlus)
- Oscillography
  - Supports IEEE C37.111-1999/2013, IEC 60255-24 Ed 2.0 COMTRADE standard
  - 128 digital & up to 56 analog channels
  - Events with up to 45s length
- Data Logger and Disturbance Recording
  - 16 channels up to 1 sample/cycle/channel

- Fault Reports
  - Powerful summary report of pre-fault and fault values

The very high sampling rate and large amounts of storage space available for data recording in the UR allows for the capture of complex events and can eliminate the need for installing costly stand-alone recording equipment.

### Advanced Device Health Diagnostics

The UR performs comprehensive device health diagnostic tests at startup and continuously during run-time to test its own major functions and critical hardware. These diagnostic tests monitor for conditions that could impact security and availability of protection, and present device status via SCADA communications and front panel display. Providing continuous monitoring and early detection of possible issues help improve system uptime.

- Comprehensive device health diagnostic performed at startup
- Monitors the CT/VT input circuitry to validate the integrity of all signals
- Monitors internal DC voltage levels that allows for proactive maintenance and increased uptime

## PMU - Synchrophasors

With the ability of having up to 6 PMU elements in one device, UR devices provide simultaneous data streams of up to four different clients.

UR devices exceed the IEEE C37.118 (2011) requirements for Total Vector Error (TVE) less than 1% over a range of 40Hz to 70Hz, and are able to measure and report synchrophasors over a frequency range from 30Hz to 90Hz with little effect on TVE.

A special feature of the synchrophasor implementation is the ability to apply magnitude and phase angle correction on a per-phase basis for known CT and PT magnitude and phase errors. Selected UR devices can apply a phase correction on each phase of up to  $\pm 5^\circ$  in increments of  $0.05^\circ$ . They also provide the ability to adjust for delta-wye phase angle shifts or polarity reversal in the synchrophasor reporting of the voltage and current sequence components.

UR devices can stream PMU data through any of its three Ethernet ports using either IEEE C37.118 or IEC 61850-90-5 data formats. When streaming PMU data through a single port, a failover function can automatically switch the transmission over another Ethernet port.

Selected UR devices also support up to 16 user-definable command outputs via the command frame defined in the IEEE C37.118 standard.

### PMU recording

UR devices include high accuracy metering and recording for all AC signals. Voltage, current, frequency, power and energy and demand metering are built into the relay as a standard feature. Current and voltage parameters are available as total RMS magnitude, and as fundamental frequency magnitude and angle. UR devices have 12MB of synchrophasor recording memory with multiple recording and triggering options. The PMU recorder can be triggered by an over/under frequency, over/under voltage, overcurrent, overpower, rate of change of frequency condition, or by a user-specified condition, freely configured through FlexLogic. The PMU status flag shows which of those functions triggered the PMU recorder.

### Monitor Multiple Power Circuits

Selected UR devices can monitor from one up to six three-phase power circuits and can be configured to simultaneously provide as many as 6 PMUs. Other configurations are: three power circuits with independent currents and voltages, four power circuits with independent currents and two common voltages, five power circuits with independent current and one common voltage. UR devices provide metering of many power system quantities including active, reactive and apparent power on a per-phase, and three-phase basis, true RMS value, phasors and symmetrical components of currents, and voltages, power factor, and frequency. Frequency can be measured independently and simultaneously from up to six different signals including currents if needed. UR devices allow for the creation and processing of virtual sums of currents through its user configuration mechanism of "signal sources", and can also sum analog values through its FlexMath elements.

### Communications

The UR provides advanced communications technologies for remote data and engineering access, making it easy and flexible to use and integrate into new and existing infrastructures. Direct support for fiber optic Ethernet provides high-bandwidth communications allowing for low-latency controls and high-speed file transfers of relay fault and event record information. The available redundant Ethernet option provides the means to create fault tolerant communication architectures in an easy, cost-effective manner without the need for intermediary communication hardware.

The UR supports the most popular industry standard protocols enabling easy, direct integration into DCS and SCADA systems.

- IEC 61850 Ed. 1 and Ed. 2 Station Bus, IEC 61850-2-2LE / IEC 61869 networked or IEC 61850-9-2 HardFiber Process Bus, and IEC 61850-90-5 PMU over GOOSE support
- DNP 3.0 (serial & TCP/IP)
- Ethernet Global Data (EGD)
- IEC 60870-5-103 and IEC 60870-5-104
- Modbus RTU, Modbus TCP/IP
- HTTP, TFTP
- IEEE 1588 and redundant SNTP for time synchronization
- PRP as per IEC 62439-3
- Supports Routable GOOSE (R-GOOSE)

### Purpose Specific LAN

The available three independent Ethernet ports enable users to segregate heavy traffic (eg.

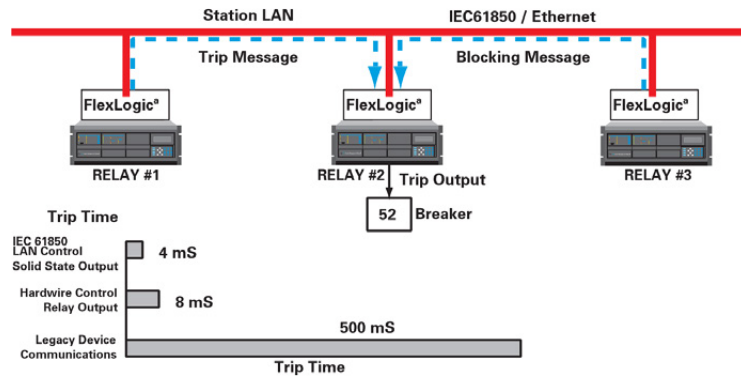

IEC 61850 protocol enables high-speed trip and control via the substation LAN without complex fixed wiring to many auxiliary devices.

synchrophasors) from mission critical services (eg. GOOSE), as a way to eliminate potential latency effects.

### Precision Time Protocol - IEEE 1588

UR devices support the IEEE 1588 v2 (2012) time synchronization protocol that enables time synchronization via the substation LAN with no sacrifice on time accuracy (1µs). IEEE 1588 removes the dedicated IRIG-B wiring and repeaters used for time synchronization that are traditionally used in substations.

### UR Switch Module

In addition to providing high-speed connectivity directly to the UR, the UR Switch Module provides an additional 4 fiber Ethernet ports, for connection to other relays in the system as well as upstream connectivity. It also provides 2 RJ45 copper Ethernet ports which can be used to connect local devices such as PCs, meters, or virtually anything else in the system.

The UR Switch Module provides a simple way to add fully-managed Ethernet networking to your relays and devices without the need for additional hardware or a dedicated communications cabinet.

The UR Switch Module includes all the management and features that come with all MultiLink managed switches, and can be easily integrated into a network that has other Ethernet switches.

When used in a ring topology with other UR switch modules or MultiLink switches, the UR Switch Module can be configured to use MultiLink's Smart RSTP feature to provide industry-leading network recovery for ring topologies, at a speed of less than 5ms per switch.

### Interoperability with Embedded IEC 61850 Ed. 1 and Ed. 2

Use the UR with integrated IEC 61850 to lower costs associated with system protection, control and automation. GE Digital Energy's leadership

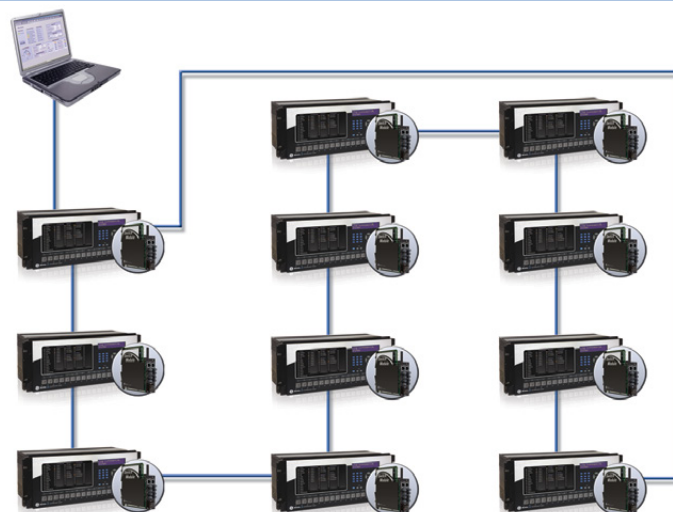

The UR Switch Module is a fully-managed Ethernet switch with a modular form factor. It can be placed directly into a GE Multilin UR to provide Ethernet connectivity to the relay as well as other Ethernet-enabled devices.

in IEC 61850 comes from thousands of installed devices and follows on extensive development experience with UCA 2.0.

- Backup wired signals or replace expensive copper wiring between devices with direct transfer of data from up to 64 remote device using GOOSE messaging.
- Configure GE systems based on IEC 61850 and also monitor and troubleshoot them in real-time with EnerVista Viewpoint Engineer
- Multicast IEEE C37.118 synchrophasor data between PMU and PDC devices using IEC 61850-90-5
- R-GOOSE enable customer to send GOOSE messages beyond the substation, which enables WAPC and more cost effective communication architectures for wide area applications
- Implements, user selectable, Ed. 1 and Ed. 2 of the standard across the entire UR Family

### LAN Redundancy

Substation LAN redundancy has been traditionally accomplished by reconfiguring the active network topology in case of failure. Regardless of the type of LAN architecture (tree, mesh, etc), reconfiguring the active LAN requires time to switchover, during which the LAN is unavailable. UR devices deliver redundancy as specified by PRP-IEC 62439-3,

which eliminates the dependency on LAN reconfiguration and the associated switchover time. The UR becomes a dual attached node that transmits data packets over both main and redundant networks simultaneously, so in case of failure, one of the data packets will reach the receiving device with no time delay.

### Direct I/O Messaging

Direct I/O allows for the sharing of analog or high-speed digital information between multiple UR relays via direct back-to-back connections or multiplexed through a standard DS0 multiplexer channel bank. Regardless of the connection method, direct I/O provides continuous real-time channel monitoring that supplies diagnostics information on channel health. Direct I/O provides superior relay-to-relay communications that can be used in advanced interlocking, generation rejection and other special protection schemes.

- Communication with up to 16 UR relays in single or redundant rings rather than strictly limited to simplistic point-to-point configurations between two devices
- Connect to standard DS0 channel banks through standard RS422, G.703 or IEEE C37.94 interfaces or via direct fiber optic connections
- No external or handheld tester required to provide channel diagnostic information

### Multi-Language

UR devices support multiple languages: English, French, Russian, Chinese, Turkish, German, Polish and Japanese. These language options are available on the front panel, in the EnerVista setup software, and in the product manuals. Easily switch between English and an additional language on the local displays without uploading new firmware.

### IEC 61869 and 61850-9-2LE Process Bus

Three UR process bus modules enable communicating to Merging Units “MU” that comply to either IEC 61869 standard or IEC 61850-9-2LE technical report. MUs connect to the primary asset and translate analog signals and digital status/commands to standard sample values “SV” data and GOOSE messages.

Flexibility for connecting to different network size and topology is granted through 100Mbps and/or 1Gbps Ethernet port support, plus IEC 62439 PRP or HSR standard redundancy, plus Star, Ring and Point-to-point network support.

For time synchronization purposes, this Process bus module can become an IEEE 1588 slave clock (61850-9-3 profile) or a 1588 Grand Master clock which removes the need of external time sources connected to the process bus network.

Customers who may not be using GE MU devices, could use MU from other vendors. Interoperability with MU from other vendors is expected when they comply to the mentioned standards.

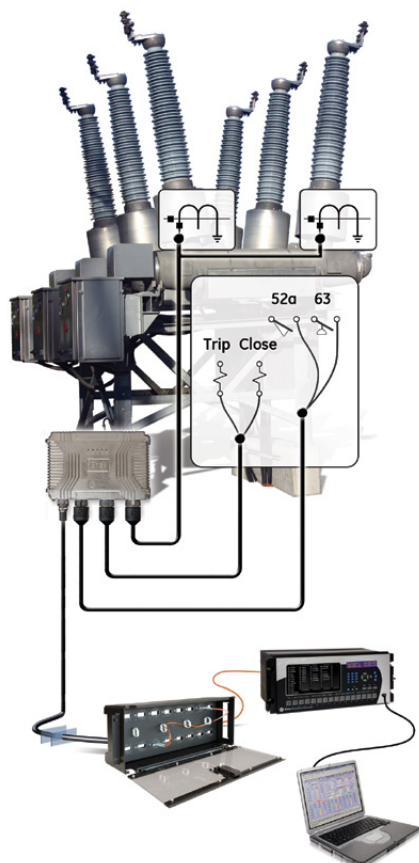

IEC 61850 protocol enables high-speed trip and control via the substation LAN without complex fixed wiring to many auxiliary devices.

#### Topologies:

PRP Start  
Hot-Stanby

#### Topologies:

HSR ring  
PRP start  
P-2-P Process Bus

Merging units

Conventional or Optical CT/VTs

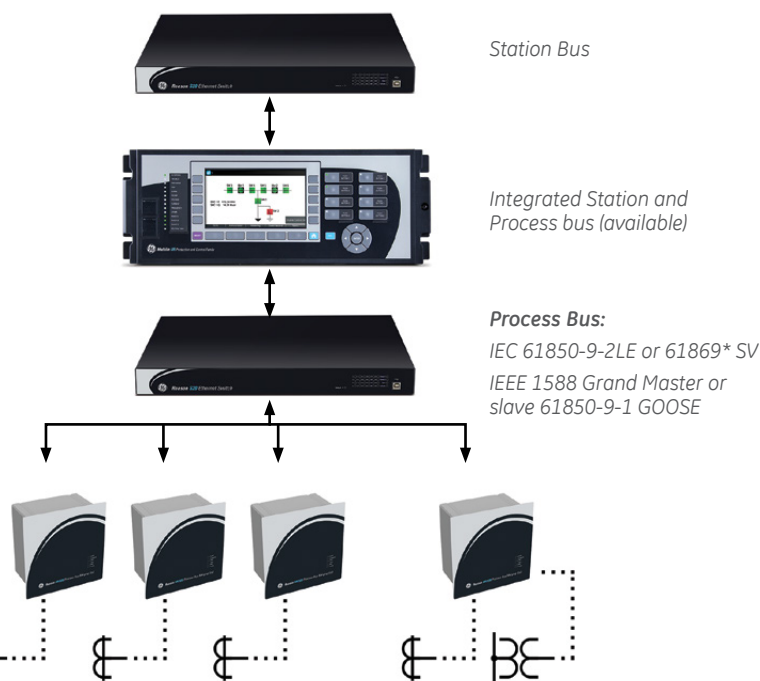

## HardFiber IEC 61850 Process Bus

The HardFiber Process Bus System represents a true breakthrough in the installation and ownership of protection and control systems, by reducing the overall labor required for substation design, construction, and testing. This innovative solution addresses the three key issues driving the labor required for protection and control design, construction and testing:

- Every substation is unique, making design and drafting a one-off solution for every station
- Miles of copper wires need to be pulled, spliced and terminated
- Time-consuming testing and troubleshooting of thousands of connections must be performed by skilled personnel

The HardFiber Process Bus System was designed to address these challenges and reduce the overall labor associated with the tasks of designing, documenting, installing and testing protection and control systems. By specifically targeting copper wiring and all of the labor it requires, the HardFiber Process Bus System allows for greater utilization and optimization of resources with the ultimate goal of reducing the total life cost (TLC) for protection and control.

## Cyber Security - CyberSentry UR

CyberSentry enables UR devices to deliver full cyber security features that help customers to comply with NERC CIP and NIST® IR 7628 cyber security requirements through supporting the following core features:

### Password Complexity

Supporting up to 20 alpha- numeric or special characters, UR passwords exceed NERC CIP requirements for password complexity. Individual passwords per role are available.

### AAA Server Support (Radius)

Enables integration with centrally managed authentication and accounting of all user activities and uses modern industry best practices and standards that meet and exceed NERC CIP requirements for authentication and password management.

### Role Based Access Control (RBAC)

Efficiently administrate users and roles within UR devices. The new and advanced access functions allow users to configure up to eight roles for up to eight configurable users with independent passwords. The standard "Remote Authentication Dial In User Service" (Radius) is used for authentication.

## Event Recorder (Syslog for SEM)

Capture all cyber security related events within a SOE element (login, logout, invalid password attempts, remote/local access, user in session, settings change, FW update, etc), and then serve and classify data by security level using standard Syslog data format. This enables UR devices to integrate with established SEM (Security Event Management) systems.

## EnerVista Software

The EnerVista suite is an industry-leading set of software programs that simplifies every aspect of using the UR. The EnerVista suite provides all the tools to monitor the status of the protected asset, maintain the relay, and integrate information measured by the UR into DCS or SCADA monitoring systems. Convenient COMTRADE and SOE viewers are an integral part of the UR setup software included with every UR relay, to carry out postmortem event analysis and ensure proper protection system operation.

### EnerVista Launchpad

EnerVista Launchpad is a powerful software package that provides users with all of the setup and support tools needed for configuring and maintaining GE Multilin products. The setup software within Launchpad allows for the configuration of devices in real-time by communicating using serial, Ethernet, or modem connections, or offline by creating setting files to be sent to devices at a later time.

Included in Launchpad is a document archiving and management system that ensures critical documentation is up-to-date and available when needed. Documents made available include:

- Manuals
- Brochures
- Application Notes and Support Documents
- Wiring Diagrams
- Guideform Specifications
- FAQ's
- Service Bulletins

### Viewpoint Monitoring

Viewpoint Monitoring is a simple-to-use and full-featured monitoring and data recording software package for small systems. Similar to small SCADA systems, Viewpoint Monitoring provides a complete HMI package with the following functionality:

- Plug-&-Play Device Monitoring
- System Single-Line Monitoring & Control
- Annunciator Alarm Screens
- Trending Reports
- Automatic Event Retrieval
- Automatic Waveform Retrieval

## Viewpoint UR Engineer

Viewpoint UR Engineer is a set of powerful tools that allows the configuration and testing of GE relays at a system level in an easy-to-use graphical drag-and-drop environment. Viewpoint UR Engineer provides the following configuration and commissioning utilities:

- Graphical Logic Designer (Substation)
- Graphical System Designer
- Graphical Logic Monitor
- Graphical System Monitor (Substation)
- IEC 61850 Configurator

### Viewpoint Maintenance

Viewpoint Maintenance provides tools that will create reports on the operating status of the relay, simplify the steps to download fault and event data, and reduce the work required for cyber security compliance audits. Tools available in Viewpoint Maintenance include:

- Settings Security Audit Report
- Device Health Report
- Single-Click Fault Data Retrieval

### EnerVista Integrator

EnerVista Integrator is a toolkit that allows seamless integration of Multilin devices into new or existing automation systems. Included in EnerVista Integrator is:

- OPC/DDE Server
- GE Multilin Drivers
- Automatic Event Retrieval
- Automatic Waveform Retrieval

## User Interface

The UR front panel provides extensive local HMI capabilities. The local display is used for monitoring, status messaging, fault diagnosis, and device configuration. User-configurable messages that combine text with live data can be displayed when user-defined conditions are met. Configurable LEDs allows status and alarm signaling (50 LEDs).

The UR<sup>Plus</sup> and UR optionally has a color graphic HMI that allows users to have customizable bay diagrams with local monitoring of status, values and control functionality.

The alarm annunciator panel provides the configuration of up to 96 (UR) or 256 signals (UR<sup>Plus</sup>) (alarms and status) with full text description.

A 7" color, graphic HMI is optionally available that allows users to have customizable bay diagrams with local monitoring of status, values and control functionality. The alarm annunciator panel provides the configuration of up to 96 signals (alarms and status) with full text description.



## Power System Troubleshooting

The UR contains many tools and reports that simplify and reduce the amount of time required for troubleshooting power system events, increase uptime and reduce loss of production.

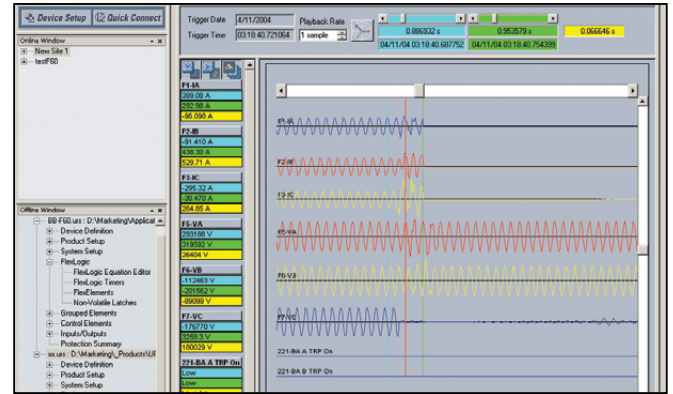
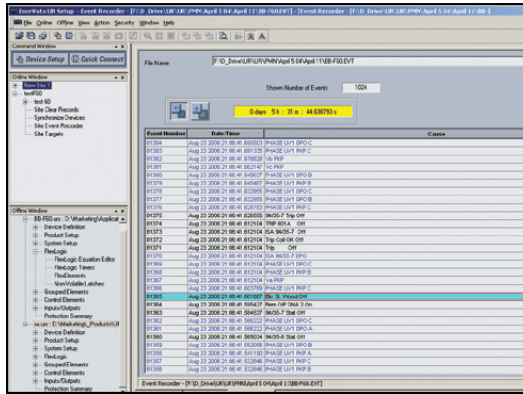

Record the operation of the internal UR elements and external connected devices with 1ms time-stamped accuracy to identify the Sequence of Operation of station devices during faults and disturbances.

Analyze faults and disturbances using both analog and digital power system quantities.

## UR Enhanced Front Panel with Large Display, Customizable LED Annunciator, and User-Programmable Pushbuttons

- LED indicators**
  - 5 device status LEDs
  - 9 event LEDs
- Front USB Port**
  - High-speed local data Transfer
- Intuitive HMI**
  - 7" large color graphic HMI
  - 5 customizable bay diagram pages with controls, status and metering values
  - 96 customizable alarms in 8 pages
  - Event record pages with dynamic updates
- 8 user programmable pushbuttons**
- Advanced Communications Capabilities**
  - Up to three Ethernet ports
  - IEC 61850, DNP 3.0, Modbus TCP/IP, IEC 60870-5-104 protocols
  - IEEE C37.118 and IEC 61850-90-5 synchrophasors over Ethernet

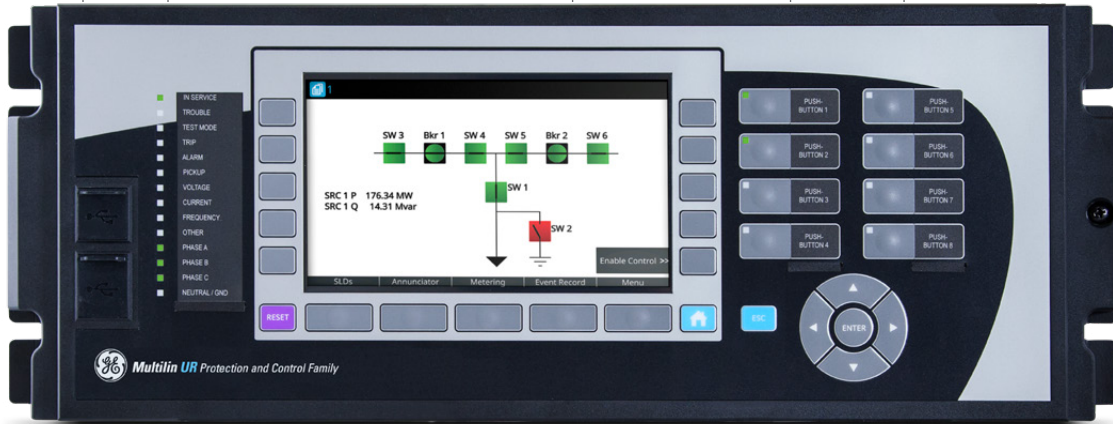

- Advanced Automation Controller**
  - Built-in programmable logic engine
  - Boolean and control operations
- 10 side screen pushbuttons for bay control and additional 10 soft user programmable pushbuttons**
- 5 below screen tab and 1 home pushbutton for page recall**
- Menu navigation keys**

## UR Horizontal Dimensions

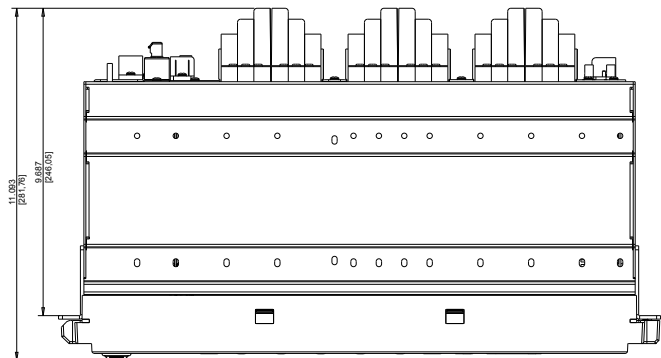
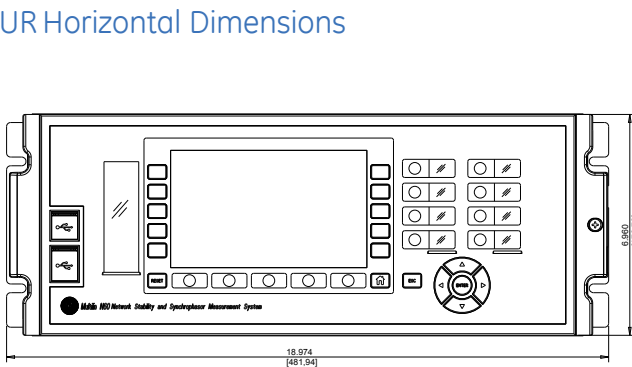

## UR<sup>Plus</sup> Front Panel with Large Color Display and Annunciator Panel

### Digital Alarm Annunciator

- 256 customizable alarms in multiple pages
- Eliminates the need for separate annunciator

### Intuitive HMI

- Customizable bay diagrams for various applications
- Local control and status indication of breakers & disconnect switches
- Local/remote control (20 programmable buttons)
- Fault, event, disturbance and transient reports

### Advanced Control

- Customizable bay diagrams for various applications
- Local control and status indication of breakers & disconnect switches
- Local/remote control
- Fault, event, disturbance and transient reports



### Advanced Automation Controller

- Built-in programmable logic engine
- Advanced math, Boolean and control operations

### Advanced Communications Capabilities

- Up to three Ethernet ports
- IEC 61850, DNP 3.0, Modbus TCP/IP, IEC 60870-5-104 protocols
- IEEE C37.118 synchrophasors over Ethernet

### Advanced Recorders

- Eliminate the need for stand-alone disturbance recorders
- 128 samples/cycle, 1 min duration transient recorder
- Separate dynamic disturbance recorder for recording long term events
- Synchrophasors PMU recording

### Front USB Port

- High-speed local data transfer

## UR<sup>Plus</sup> Dimensions

HORIZONTAL FRONT VIEW

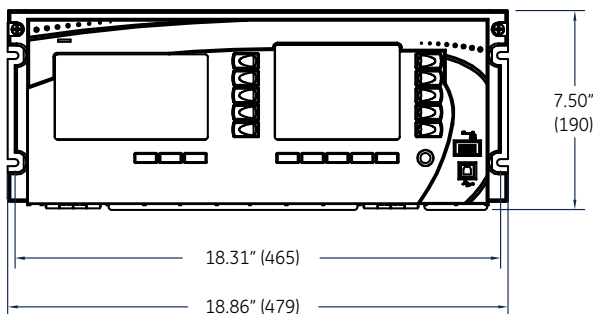

HORIZONTAL TOP VIEW

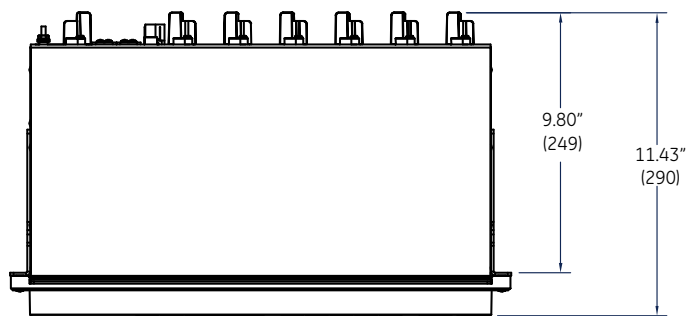

## UR Enhanced Front Panel - Vertical Faceplate



## UR Vertical Dimensions

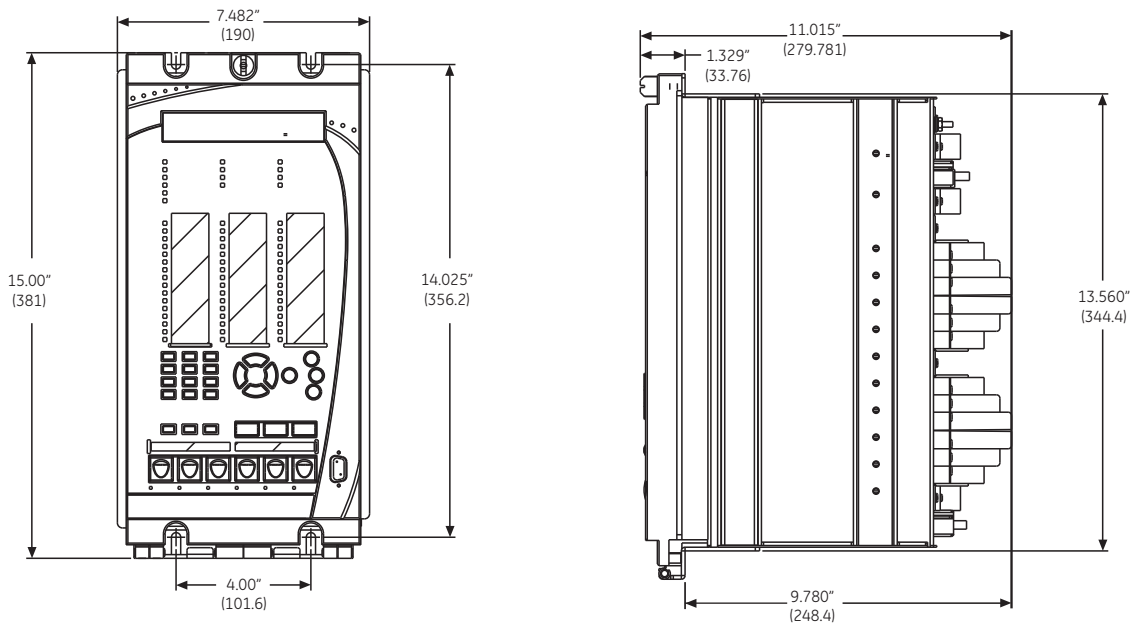

# UR Family Selector Guide

Family Overview

| Features                                                 | ANSI  | B30 | B90 | B95 <sup>Plus</sup> | C30 | C60 | C70 | C90 <sup>Plus</sup> | D30   | D60 | D90 <sup>Plus</sup> |
|----------------------------------------------------------|-------|-----|-----|---------------------|-----|-----|-----|---------------------|-------|-----|---------------------|
| <b>Protection</b>                                        |       |     |     |                     |     |     |     |                     |       |     |                     |
| Disturbance Detector                                     |       |     |     |                     |     |     | •   | •                   | •     | •   | •                   |
| Mho Distance, Phase (No. of Zones)                       | 21P   |     |     |                     |     |     |     |                     | 5     | 5   | 5                   |
| Mho Distance, Ground or Neutral Phase (No. of Zones)     | 21G/N |     |     |                     |     |     |     |                     | 5     | 5   | 5                   |
| Quadrilateral Distance, Phase (No. of Zones)             | 21P   |     |     |                     |     |     |     |                     | 5     | 5   | 5                   |
| Quadrilateral Distance, Ground or Neutral (No. of Zones) | 21G/N |     |     |                     |     |     |     |                     | 5     | 5   | 5                   |
| Permissive Pilot Logic                                   |       |     |     |                     |     |     |     |                     |       | •   | •                   |
| Sub-Cycle Distance                                       |       |     |     |                     |     |     |     |                     |       |     | •                   |
| Overexcitation Protection (V/Hz)                         | 24    |     |     |                     |     |     |     |                     |       |     |                     |
| Synchronism Check or Synchronizing                       | 25    |     |     |                     |     | •   |     | •                   | •     | •   | •                   |
| Undervoltage, Phase                                      | 27P   | •   | •   | •                   |     | •   | •   | •                   | •     | •   | •                   |
| Undervoltage, Auxiliary                                  | 27X   |     |     |                     |     | •   |     | •                   | •     | •   | •                   |
| Stator Ground (3rd Harmonic)                             | 27TN  |     |     |                     |     |     |     |                     |       |     |                     |
| Sensitive Directional Power                              | 32S   |     |     |                     |     | •   |     | •                   |       |     |                     |
| Loss of Excitation – Based on Reactive Power             | 40Q   |     |     |                     |     |     |     |                     |       |     |                     |
| Loss of Excitation – Based on Impedance Element          | 40    |     |     |                     |     |     |     |                     |       |     |                     |
| Current Unbalance                                        | 46    |     |     |                     |     |     |     |                     |       |     |                     |
| Broken Conductor Detection                               | 46BC  |     |     |                     |     |     |     |                     |       |     |                     |
| IOC, Negative Sequence                                   | 46/50 |     |     |                     |     |     | •   | •                   | •     | •   | •                   |
| TOC, Negative Sequence                                   | 46/51 |     |     |                     |     |     | •   | •                   | •     | •   | •                   |
| Current Directional, Negative Sequence                   | 46/67 |     |     |                     |     |     | •   | •                   | •     | •   | •                   |
| Reverse Phase Sequence Voltage                           | 47    |     |     |                     |     |     |     | •                   |       |     |                     |
| Thermal Model                                            | 49    |     |     |                     |     |     |     |                     |       |     |                     |
| Inadvertent/Accidental Energization                      | 50/27 |     |     |                     |     |     |     |                     |       |     |                     |
| End of Fault Protection                                  |       | •   | •   | •                   |     |     |     |                     |       |     |                     |
| Motor Mechanical Jam                                     |       |     |     |                     |     |     |     |                     |       |     |                     |
| Motor Start Supervision                                  |       |     |     |                     |     |     |     |                     |       |     |                     |
| Motor Acceleration Time                                  |       |     |     |                     |     |     |     |                     |       |     |                     |
| User Programmable Curves                                 |       | •   |     |                     |     | •   | •   | •                   | •     | •   | •                   |
| Breaker Failure                                          | 50BF  | •   | •   | •                   |     | •   | •   | •                   | Logic | •   | •                   |
| IOC, Phase                                               | 50P   | •   | •   | •                   |     | •   | •   | •                   | •     | •   | •                   |
| IOC, Ground                                              | 50G   | •   |     |                     |     | •   | •   | •                   | •     | •   | •                   |
| IOC, Neutral                                             | 50N   | •   |     |                     |     | •   | •   | •                   | •     | •   | •                   |
| IOC, Sensitive Ground                                    | 50SG  | •   |     |                     |     | •   |     |                     | •     | •   |                     |
| High Impedance Fault Detection                           |       |     |     |                     |     |     |     |                     |       |     |                     |
| TOC, Phase                                               | 51P   | •   | •   | •                   |     | •   | •   | •                   | •     | •   | •                   |
| TOC, Ground                                              | 51G   | •   |     |                     |     | •   | •   | •                   | •     | •   | •                   |
| TOC, Neutral                                             | 51N   | •   |     |                     |     | •   | •   | •                   | •     | •   | •                   |
| TOC, Sensitive Ground                                    | 51SG  | •   |     |                     |     | •   |     |                     | •     | •   |                     |
| TOC, Voltage Restrained                                  | 51V   | •   |     |                     |     | •   | •   | •                   | •     | •   | •                   |
| Overvoltage, Phase                                       | 59P   |     |     |                     |     | •   | •   | •                   | •     | •   | •                   |
| Overvoltage, Auxiliary                                   | 59A   | •   |     |                     |     | •   | •   | •                   | •     | •   | •                   |
| Overvoltage, Neutral                                     | 59N   | •   |     |                     |     | •   | •   | •                   | •     | •   | •                   |
| Negative Sequence Overvoltage                            | 59-2  |     |     |                     |     |     | •   | •                   | •     | •   | •                   |
| 100% Stator Ground Protection                            | 64TN  |     |     |                     |     |     |     |                     |       |     |                     |
| Current Directional, Phase                               | 67P   |     |     |                     |     |     |     | •                   | •     | •   | •                   |
| Current Directional, Neutral                             | 67N   |     |     |                     |     |     |     | •                   | •     | •   | •                   |
| Current Directional, Negative Sequence                   | 46/67 |     |     |                     |     |     |     | •                   | •     | •   | •                   |
| Power Swing Blocking                                     | 68    |     |     |                     |     |     |     |                     | •     | •   | •                   |
| Out-of-Step Tripping                                     | 78    |     |     |                     |     |     |     |                     | •     | •   | •                   |
| AC Reclosing (No. of Shots)                              | 79    |     |     |                     |     | 4   |     | 4                   | 4     | 4   | •                   |
| Switch on to Fault (Line Pickup)                         | SOTF  |     |     |                     |     |     |     |                     | •     | •   | •                   |
| Voltage Transformer Fuse Failure                         | VTFF  |     |     |                     |     | •   | •   | •                   | •     | •   | •                   |
| Current Transformer Supervision                          | 50/74 | •   | •   | •                   |     |     |     |                     |       |     |                     |
| Load Encroachment Logic                                  |       |     |     |                     |     |     |     |                     | •     | •   | •                   |
| Underfrequency                                           | 81U   |     |     |                     |     |     |     | •                   |       | •   | •                   |
| Overfrequency                                            | 81O   |     |     |                     |     |     |     | •                   |       | •   | •                   |
| Anti-Islanding Protection/Frequency Rate of Change       | 81R   |     |     |                     |     |     |     | •                   |       | •   | •                   |
| Lockout Functionality                                    | 86    | •   | •   | •                   | •   | •   | •   | •                   | •     | •   | •                   |
| Bus Differential                                         | 87B   | 2   | 2   | 2                   |     |     |     |                     |       |     |                     |
| Line Current Differential                                | 87L   |     |     |                     |     |     |     |                     |       |     |                     |
| Ground Differential                                      | 87G   |     |     |                     |     |     |     |                     |       |     |                     |
| Stator Differential                                      | 87S   |     |     |                     |     |     |     |                     |       |     |                     |
| Transformer Differential                                 | 87T   |     |     |                     |     |     |     |                     |       |     |                     |
| Line Phase Comparison                                    | 87PC  |     |     |                     |     |     |     |                     |       |     |                     |
| Voltage Differential                                     |       |     |     |                     |     |     | •   |                     |       |     |                     |
| Capacitor Bank Overvoltage                               |       |     |     |                     |     |     | •   |                     |       |     |                     |
| Neutral Voltage Unbalance                                |       |     |     |                     |     |     | •   |                     |       |     |                     |
| Automatic Voltage Regulation                             |       |     |     |                     |     |     | •   |                     |       |     |                     |
| Time of Day Control                                      |       |     |     |                     |     |     | •   |                     |       |     |                     |
| Instantaneous Differential                               | 50/87 | •   | •   | •                   |     |     |     |                     |       |     |                     |
| Split Phase Protection                                   |       |     |     |                     |     |     |     |                     |       |     |                     |
| Line Current Differential Trip Logic                     |       |     |     |                     |     |     |     |                     |       |     |                     |
| CT Failure                                               |       | •   | •   |                     |     |     |     |                     |       |     |                     |



Features F35 F60 G30 G60 L30 L60 L90 M60 N60 T35 T60

| Protection                                               | F35   | F60 | G30   | G60 | L30 | L60 | L90 | M60 | N60   | T35   | T60   |
|----------------------------------------------------------|-------|-----|-------|-----|-----|-----|-----|-----|-------|-------|-------|
| Disturbance Detector                                     |       | •   |       |     | •   | •   | •   |     | •     |       |       |
| Mho Distance, Phase (No. of Zones)                       |       |     |       | 3   |     | 3   | 5   |     |       |       | 5     |
| Mho Distance, Ground or Neutral Phase (No. of Zones)     |       |     |       |     |     | 3   | 3   |     |       |       | 5     |
| Quadrilateral Distance, Phase (No. of Zones)             |       |     |       |     |     | 3   | 3   |     |       |       | 5     |
| Quadrilateral Distance, Ground or Neutral (No. of Zones) |       |     |       |     |     | 3   | 3   |     |       |       | 5     |
| Permissive Pilot Logic                                   |       |     |       |     |     |     | •   |     |       |       |       |
| Sub-Cycle Distance                                       |       |     |       |     |     |     |     |     |       |       |       |
| Overexcitation Protection (V/Hz)                         |       |     | •     | •   |     |     |     |     |       |       | •     |
| Synchronism Check or Synchronizing                       |       | •   | •     | •   | •   | •   | •   |     | •     |       | •     |
| Undervoltage, Phase                                      | •     | •   | •     | •   | •   | •   | •   |     | •     |       | •     |
| Undervoltage, Auxiliary                                  | •     | •   | •     | •   | •   | •   | •   |     | •     |       | •     |
| Stator Ground (3rd Harmonic)                             |       |     | •     | •   |     |     |     |     |       |       |       |
| Sensitive Directional Power                              |       | •   | •     | •   |     |     |     | •   | •     |       |       |
| Loss of Excitation - Based on Reactive Power             |       |     | •     | •   |     |     |     | •   |       |       |       |
| Loss of Excitation - Based on Impedance Element          |       |     | •     | •   |     |     |     |     |       |       |       |
| Current Unbalance                                        |       |     | •     | •   |     |     |     | •   |       |       |       |
| Broken Conductor Detection                               |       | •   |       |     |     |     |     |     |       |       |       |
| IOC, Negative Sequence                                   |       | •   |       |     | •   | •   | •   |     |       |       |       |
| TOC, Negative Sequence                                   |       | •   |       |     | •   | •   | •   |     |       |       |       |
| Current Directional, Negative Sequence                   |       | •   | •     | •   |     | •   | •   |     |       |       |       |
| Reverse Phase Sequence Voltage                           |       |     |       |     |     |     |     | •   |       |       |       |
| Thermal Model                                            |       |     |       | •   |     |     |     | •   |       |       | •     |
| Inadvertent/Accidental Energization                      |       |     | •     | •   |     |     |     |     |       |       |       |
| End of Fault Protection                                  |       |     |       |     |     |     |     |     |       |       |       |
| Motor Mechanical Jam                                     |       |     |       |     |     |     |     | •   |       |       |       |
| Motor Start Supervision                                  |       |     |       |     |     |     |     | •   |       |       |       |
| Motor Acceleration Time                                  |       |     |       |     |     |     |     | •   |       |       |       |
| User Programmable Curves                                 | •     | •   | •     | •   | •   | •   | •   | •   | •     | •     | •     |
| Breaker Failure                                          | Logic | •   | Logic | •   | •   | •   | •   | •   | Logic | Logic | Logic |
| IOC, Phase                                               | •     | •   | •     | •   | •   | •   | •   | •   | •     |       | •     |
| IOC, Ground                                              | •     | •   | •     | •   | •   | •   | •   | •   |       |       | •     |
| IOC, Neutral                                             | •     | •   | •     | •   | •   | •   | •   | •   |       |       | •     |
| IOC, Sensitive Ground                                    | •     | •   | •     | •   | •   | •   | •   | •   |       |       | •     |
| High Impedance Fault Detection                           |       | •   |       |     |     |     |     |     |       |       |       |
| TOC, Phase                                               | •     | •   | •     | •   | •   | •   | •   | •   |       | •     | •     |
| TOC, Ground                                              | •     | •   | •     | •   | •   | •   | •   | •   |       | •     | •     |
| TOC, Neutral                                             | •     | •   | •     | •   | •   | •   | •   | •   |       | •     | •     |
| TOC, Sensitive Ground                                    | •     | •   | •     | •   | •   | •   | •   | •   |       | •     | •     |
| TOC, Voltage Restrained                                  | •     | •   | •     | •   | •   | •   | •   | •   |       | •     | •     |
| Overvoltage, Phase                                       |       | •   | •     | •   | •   | •   | •   | •   |       |       | •     |
| Overvoltage, Auxiliary                                   | •     | •   | •     | •   | •   | •   | •   | •   |       |       | •     |
| Overvoltage, Neutral                                     | •     | •   | •     | •   | •   | •   | •   | •   |       |       | •     |
| Negative Sequence Overvoltage                            |       | •   | •     | •   |     |     |     | •   |       |       |       |
| 100% Stator Ground Protection                            |       |     | •     | •   |     |     |     |     |       |       |       |
| Current Directional, Phase                               |       | •   | •     | •   |     | •   | •   | •   |       |       | •     |
| Current Directional, Neutral                             |       | •   | •     | •   |     | •   | •   | •   |       |       | •     |
| Current Directional, Negative Sequence                   |       | •   | •     | •   |     | •   | •   | •   |       |       | •     |
| Power Swing Blocking                                     |       |     |       | •   |     | •   | •   | •   |       |       | •     |
| Out-of-Step Tripping                                     |       |     |       | •   |     | •   | •   | •   |       |       | •     |
| AC Reclosing (No. of Shots)                              | 4     | 4   |       |     | 4   | 4   | 4   |     |       |       |       |
| Switch on to Fault (Line Pickup)                         |       |     |       |     |     | •   | •   |     |       |       |       |
| Voltage Transformer Fuse Failure                         | •     | •   | •     | •   | •   | •   | •   | •   | •     |       | •     |
| Current Transformer Supervision                          |       |     |       |     | •   | •   | •   |     |       |       |       |
| Load Encroachment Logic                                  |       | •   |       |     |     | •   | •   |     |       |       | •     |
| Underfrequency                                           | •     | •   | •     | •   | •   |     |     |     | •     |       | •     |
| Overfrequency                                            |       | •   | •     | •   |     |     |     |     | •     |       | •     |
| Anti-Islanding Protection/Frequency Rate of Change       |       | •   | •     | •   |     |     | •   |     | •     |       | •     |
| Lockout Functionality                                    | •     | •   | •     | •   |     | •   | •   | •   | •     | •     | •     |
| Bus Differential                                         |       |     |       |     |     |     |     |     |       |       |       |
| Line Current Differential                                |       |     |       |     | •   |     | •   |     |       |       |       |
| Ground Differential                                      |       | •   | •     | •   | •   |     | •   |     |       |       | •     |
| Stator Differential                                      |       |     | •     | •   |     |     |     | •   |       |       |       |
| Transformer Differential                                 |       |     | •     |     |     |     |     |     |       | •     | •     |
| Line Phase Comparison                                    |       |     |       |     |     | •   |     |     |       |       |       |
| Voltage Differential                                     |       |     |       |     |     |     |     |     |       |       |       |
| Capacitor Bank Overvoltage                               |       |     |       |     |     |     |     |     |       |       |       |
| Neutral Voltage Unbalance                                |       |     |       |     |     |     |     |     |       |       |       |
| Automatic Voltage Regulation                             |       |     |       |     |     |     |     |     |       |       |       |
| Time of Day Control                                      |       |     |       |     |     |     |     |     |       |       |       |
| Instantaneous Differential                               |       |     |       |     |     |     |     |     |       | •     | •     |
| Split Phase Protection                                   |       |     | •     | •   |     |     |     |     |       |       |       |
| Line Current Differential Trip Logic                     |       |     |       |     |     |     | •   |     |       |       |       |
| CT Failure                                               |       |     | •     | •   | •   | •   | •   | •   |       | •     | •     |

UR Technical Specifications

PROTECTION

100% STATOR GROUND

Operating quantity:  $V_{neutral\_3rd}/V_{neutral\_3rd} + V_{zero\_3rd}$   
 Pickup level: 0.000 to 0.250 pu in steps of 0.001  
 Dropout level: 97 to 98% of pickup  
 Level accuracy:  $\pm 2\%$  of reading from 1 to 120 V  
 Pickup delay: 0 to 600.00 s in steps of 0.01  
 3rd harmonic supervision level: 0.0010 to 0.1000 pu in steps of 0.0001  
 Time accuracy:  $\pm 3\%$  or  $\pm 20$  ms, whichever is greater  
 Operate time:  $< 30$  ms at  $1.10 \times$  Pickup at 60 Hz  
**ACCELERATION TIME**  
 Acceleration current: 1.00 to  $10.00 \times$  FLA in steps of 0.01  
 Acceleration time: 0.00 to 180.00 s in steps of 0.01  
 Operating mode: Definite Time, Adaptive  
**ACCIDENTAL ENERGIZATION**  
 Operating condition: Overcurrent  
 Arming condition: Undervoltage and/or Machine Offline  
 Overcurrent:  
 Pickup level: 0.02 to 3.000 pu in steps of 0.001  
 Dropout level: 97 to 98% of pickup  
 Level accuracy:  $\pm 0.5\%$  of reading from 0.1 to  $2.0 \times$  CT rating

Undervoltage:  
 Pickup level: 0.004 to 3.000 pu in steps of 0.001  
 Dropout level: 102 to 103% of pickup  
 Level accuracy:  $\pm 0.5\%$  of reading 10 to 208 V  
 Operate Time:  $< 30$  ms at  $1.10 \times$  Pickup at 60 Hz  
**AUTORECLOSURE C60/D60/L90/L60**  
 Two breakers applications  
 Single- and three-pole tripping schemes  
 Up to 4 reclose attempts before lockout  
 Selectable reclosing mode and breaker sequence  
**AUTORECLOSURE F60/F35/D30**  
 Single breaker applications, 3-pole tripping schemes  
 Up to 4 reclose attempts before lockout  
 Independent dead time setting before each shot  
 Possibility of changing protection settings after each shot with FlexLogic.

AMP UNBALANCE

Avg and Full Load RMS  
 I<sub>1</sub> and I<sub>2</sub> amps: Phasor  
 Pickup level: 0.0 to 100.0% in steps of 0.1  
 Dropout level: 97 to 98% of pickup  
 Level accuracy:  $\pm 0.1$   
 Pickup delay: 0.00 to 600.00 s in steps of 0.01  
 Reset delay: 0.00 to 600.00 s in steps of 0.01  
 Operate time:  $< 20$  ms at  $1.10 \times$  pickup at 60 Hz  
 Timing accuracy:  $\pm 3\%$  or  $\pm 20$  ms, whichever is greater  
**AUXILIARY OVERVOLTAGE**  
 Pickup level: 0.004 to 3.000 pu in steps of 0.001  
 Dropout level: 97 to 98% of Pickup  
 Level accuracy:  $\pm 0.5\%$  of reading from 10 to 208 V  
 Pickup delay: 0 to 600.00 s in steps of 0.01  
 Reset delay: 0 to 600.00 s in steps of 0.01  
 Timing accuracy:  $\pm 3\%$  of operate time or  $\pm 4$  ms (whichever is greater)

AUXILIARY UNDERVOLTAGE

Pickup level: 0.004 to 3.000 pu in steps of 0.001  
 Dropout level: 102 to 103% of pickup  
 Level accuracy:  $\pm 0.5\%$  of reading from 10 to 208 V  
 Curve shapes: GE IAV Inverse, Definite Time  
 Curve multiplier: Time Dial = 0 to 600.00 in steps of 0.01  
 Timing accuracy:  $\pm 3\%$  of operate time or  $\pm 4$  ms (whichever is greater)

BREAKER ARCING CURRENT

Principle: Accumulates breaker duty (I<sup>2</sup>t) and measures fault duration  
 Initiation: Programmable per phase from any FlexLogic operand  
 Compensation for auxiliary relays: 0 to 65.535 s in steps of 0.001  
 Alarm threshold: 0 to 50000 kA<sup>2</sup>-cycle in steps of 1  
 Fault duration accuracy: 0.25 of a power cycle  
 Availability: 1 per CT bank with a minimum of 2

PROTECTION

BREAKER FAILURE

Mode: 1-pole, 3-pole  
 Current supervision: phase, neutral current  
 Current supv.: 0.02 to 30.000 pu in steps of 0.001  
 pickup:  
 Current supv. dropout: 97 to 98% of pickup  
 Current supv. accuracy: 0.1 to  $2.0 \times$  CT rating:  $\pm 0.75\%$  of reading or  $\pm 2\%$  of rated (whichever is greater)  
**BREAKER FLASHOVER**  
 Operating quantity: Phase current, voltage and voltage difference  
 Pickup level voltage: 0.02 to 1.500 pu in steps of 0.001  
 Dropout level voltage: 97 to 98% of pickup  
 Pickup level current: 0.004 to 1.500 pu in steps of 0.001  
 Dropout level current: 97 to 98% of pickup  
 Level accuracy:  $\pm 0.5\%$  or  $\pm 0.1\%$  of rated, whichever is greater

Pickup delay: 0 to 65.535 s in steps of 0.001  
 Time accuracy:  $\pm 3\%$  or  $\pm 42$  ms, whichever is greater  
 Operate time:  $< 42$  ms at  $1.10 \times$  pickup at 60 Hz  
**BUS DIFFERENTIAL (87B)**  
 Pickup level: 0.050 to 6.000 pu in steps of 0.001  
 Low slope: 15 to 100% in steps of 1  
 High slope: 50 to 100% in steps of 1  
 Low breakpoint: 1.00 to 30.00 pu in steps of 0.01  
 High breakpoint: 1.00 to 30.00 pu in steps of 0.01  
 High set level: 0.10 to 99.99 pu in steps of 0.01  
 Dropout level: 97 to 98% of Pickup  
 Level accuracy:  $\pm 0.5\%$  of reading or  $\pm 1\%$  of rated (whichever is greater)

**CT TROUBLE**  
 Responding to: Differential current  
 Pickup level: 0.020 to 2.000 pu in steps of 0.001  
 Pickup delay: 1.0 to 60.0 sec. in steps of 0.1  
 Time Accuracy:  $\pm 3\%$  or  $\pm 40$ ms, whichever is greater  
 Availability: 1 per zone of protection (B90)  
**GENERATOR UNBALANCE**  
 Gen. nominal current: 0.000 to 1.250 pu in steps of 0.001  
 Stages: 2 (I<sub>2</sub>t with linear reset and definite time)  
 Pickup level: 0.00 to 100.00% in steps of 0.01  
 Dropout level: 97 to 98% of pickup  
 Level accuracy:  $\pm 1.5\%$  of reading  
**GROUND DISTANCE**  
 CT rating:  $> 2.0 \times$  CT rating  
 Operating time: one power system cycle (typical)

**CT TROUBLE**  
 Responding to: Differential current  
 Pickup level: 0.020 to 2.000 pu in steps of 0.001  
 Pickup delay: 1.0 to 60.0 sec. in steps of 0.1  
 Time Accuracy:  $\pm 3\%$  or  $\pm 40$ ms, whichever is greater  
 Availability: 1 per zone of protection (B90)  
**GENERATOR UNBALANCE**  
 Gen. nominal current: 0.000 to 1.250 pu in steps of 0.001  
 Stages: 2 (I<sub>2</sub>t with linear reset and definite time)  
 Pickup level: 0.00 to 100.00% in steps of 0.01  
 Dropout level: 97 to 98% of pickup  
 Level accuracy:  $\pm 1.5\%$  of reading or  $\pm 1\%$  of rated (whichever is greater)  
**GROUND DISTANCE**  
 CT rating:  $> 2.0 \times$  CT rating  
 Operating time: one power system cycle (typical)  
**GROUND DISTANCE**  
 Characteristic: Mho (memory polarized or offset) or Quad (memory polarized or non-directional), selectable individually per zone  
 Reactance polarization: negative-sequence or zero-sequence current  
 Non-homogeneity angle:  $-40$  to  $40^\circ$  in steps of 1  
 Number of zones: 5  
 Directionality: Forward, Reverse, or Non-Directional per zone  
 Reach (secondary W): 0.02 to 250.00 in steps of 0.01  
 Reach accuracy:  $\pm 5\%$  including the effect of CVT transients up to an SIR of 30  
 Distance characteristic angle: 30 to  $90^\circ$  in steps of 1  
 Distance comparator limit angle:  
 Directional supervision  
 Characteristic angle: 30 to  $90^\circ$  in steps of 1  
 Limit angle: 30 to  $90^\circ$  in steps of 1

Zero-sequence compensation  
 Z0/Z1 magnitude: 0.00 to 10.00 in steps of 0.01  
 Z0/Z1 angle:  $-90$  to  $90^\circ$  in steps of 1  
 Zero-sequence mutual compensation  
 Z0M/Z1 magnitude: 0.00 to 7.00 in steps of 0.01  
 Z0M/Z1 angle:  $-90$  to  $90^\circ$  in steps of 1  
 Right blinder (Quad only):  
 Reach: 0.02 to 500 in steps of 0.01  
 Characteristic angle: 60 to  $90^\circ$  in steps of 1  
 Left blinder (Quad only):  
 Reach: 0.02 to 500 in steps of 0.01  
 Characteristic angle: 60 to  $90^\circ$  in steps of 1  
 Time delay: 0.000 to 65.535 s in steps of 0.001

PROTECTION

Timing accuracy:  $\pm 3\%$  or 4 ms, whichever is greater  
 Current supervision:  
 Level: neutral current (3I<sub>0</sub>)  
 Pickup: 0.050 to 30.000 pu in steps of 0.001  
 Dropout: 97 to 98%  
 Memory duration: 5 to 25 cycles in steps of 1  
 Voltage supervision pickup (series compensation applications): 1 to 1.5 cycles (typical)  
 Operate time: 1 power cycle (typical)  
**GROUND DISTANCE OPERATING TIME CURVES**

The operating times are response times of a microprocessor part of the relay. See output contacts specifications for estimation of the total response time for a particular application. The operating times are average times including variables such as fault inception angle or type of a voltage source (magnetic VTs and CVTs).

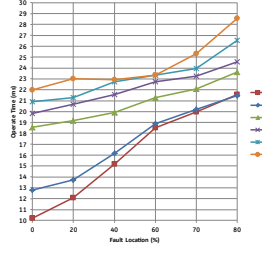

LINE CURRENT DIFFERENTIAL (87L)

Application: 2 or 3 terminal line, series compensated line, tapped line, with charging current compensation  
 Pickup current level: 0.20 to 4.00 pu in steps of 0.01  
 CT Tap (CT mismatch factor): 0.20 to 5.00 in steps of 0.01  
 Slope # 1: 1 to 50%  
 Slope # 2: 1 to 70%  
 Breakpoint between slopes: 0.0 to 20.0 pu in steps of 0.1  
 DTT: Direct Transfer Trip (1 and 3 pole) remote L90  
 Operating Time: 1.0 to 1.5 power cycles duration  
 Asymmetrical channel delay compensation using GPs: asymmetry up to 10ms

LINE CURRENT DIFFERENTIAL TRIP LOGIC

87L trip: Adds security for trip decision; creates 1 and 3 pole trip logic  
 Engaged Direct Transfer Trip (1 and 3 pole) from remote L90  
 DD: Sensitive Disturbance Detector to detect fault occurrence  
 Stub bus protection: Security for ring bus and 1/2 breaker configurations  
 Open pole detector: Security for sequential and evolving faults

LINE PICKUP

Phase IOC: 0.02 to 30.000 pu  
 Undervoltage pickup: 0.004 to 3.000 pu  
 Overvoltage delay: 0.000 to 65.535 s

LOAD ENCRACEMENT

Responds to: Positive-sequence quantities  
 Minimum voltage: 0.004 to 3.000 pu in steps of 0.001  
 Reach (sec. W): 0.02 to 250.00 in steps of 0.01  
 Impedance accuracy:  $\pm 5\%$   
 Angle: 5 to  $50^\circ$  in steps of 1  
 Angle accuracy:  $\pm 2^\circ$   
 Pickup delay: 0 to 65.535 s in steps of 0.001  
 Reset delay: 0 to 65.535 s in steps of 0.001  
 Time accuracy:  $\pm 3\%$  or  $\pm 4$  ms, whichever is greater  
 Operate time:  $< 30$  ms at 60 Hz

LOSS OF EXCITATION

Operating condition: Positive-sequence impedance  
 Characteristic: 2 independent offset mho circles  
 Center: 0.10 to 300.0 (sec.) in steps of 0.01  
 Radius: 0.10 to 300.0 (sec.) in steps of 0.01  
 Reach accuracy:  $\pm 3\%$   
 Undervoltage supervision  
 Level: 0.000 to 1.250 pu in steps of 0.001  
 Accuracy:  $\pm 0.5\%$  of reading from 10 to 208V  
 Pickup delay: 0 to 65.535 s in steps of 0.001  
 Timing accuracy:  $\pm 3\%$  or  $\pm 20$  ms, whichever is greater  
 Operate time:  $< 50$  ms



## UR Technical Specifications

| PROTECTION                         |                                                                                     |
|------------------------------------|-------------------------------------------------------------------------------------|
| <b>POWER SWING DETECT</b>          |                                                                                     |
| Functions:                         | Power swing block, Out-of-step trip                                                 |
| Characteristic:                    | Mho or Quad                                                                         |
| Measured impedance:                | Positive-sequence                                                                   |
| Blocking / tripping zones:         | 2-step or 3-step                                                                    |
| Tripping mode:                     | Early or Delayed                                                                    |
| Current supervision:               |                                                                                     |
| Pickup level:                      | 0.050 to 30.000 pu in steps of 0.001                                                |
| Dropout level:                     | 97 to 98% of Pickup                                                                 |
| Fwd / reverse reach (sec. W):      | 0.10 to 500.00W in steps of 0.01                                                    |
| Left and right blinders (sec. W):  | 0.10 to 500.00W in steps of 0.01                                                    |
| Impedance accuracy:                | ±5%                                                                                 |
| Fwd / reverse angle impedances:    | 40 to 90° in steps of 1                                                             |
| Angle accuracy:                    | ±2°                                                                                 |
| Characteristic limit angles:       | 40 to 140° in steps of 1                                                            |
| Timers:                            | 0.000 to 65.535 s in steps of 0.001                                                 |
| Timing accuracy:                   | ±3% or 4 ms, whichever is greater                                                   |
| <b>RATE OF CHANGE OF FREQUENCY</b> |                                                                                     |
| df/dt trend:                       | increasing, decreasing, bi-directional                                              |
| df/dt pickup level:                | 0.10 to 15.00 Hz/s in steps of 0.01                                                 |
| df/dt dropout level:               | 96% of pickup                                                                       |
| df/dt level accuracy:              | 80 mHz/s or 3.5%, whichever is greater                                              |
| Overvoltage supv.:                 | 0.02 to 3.000 pu in steps of 0.001                                                  |
| Overcurrent supv.:                 | 0.000 to 30.000 pu in steps of 0.001                                                |
| Pickup delay:                      | 0 to 65.535 s in steps of 0.001                                                     |
| Reset delay:                       | 0 to 65.535 s in steps of 0.001                                                     |
| Time accuracy:                     | ±3% or ±4 ms, whichever is greater                                                  |
| 95% settling time for df/dt:       | < 24 cycles                                                                         |
| Operate time:                      |                                                                                     |
| at 2 x pickup:                     | 12 cycles                                                                           |
| at 3 x pickup:                     | 8 cycles                                                                            |
| at 5 x pickup:                     | 6 cycles                                                                            |
| <b>RESTRICTED GROUND FAULT</b>     |                                                                                     |
| Pickup:                            | 0.000 to 30.000 pu in steps of 0.001                                                |
| Dropout:                           | 97 to 98% of Pickup                                                                 |
| Slope:                             | 0 to 100% in steps of 1%                                                            |
| Pickup delay:                      | 0 to 600.00 s in steps of 0.01                                                      |
| Dropout delay:                     | 0 to 600.00 s in steps of 0.01                                                      |
| Operate time:                      | < 1 power system cycle                                                              |
| <b>SENSITIVE DIRECTIONAL POWER</b> |                                                                                     |
| Measured power:                    | 3-phase, true RMS                                                                   |
| Number of stages:                  | 2                                                                                   |
| Characteristic angle:              | 0 to 359° in steps of 1                                                             |
| Calibration angle:                 | 0.00 to 0.95° in steps of 0.05                                                      |
| Minimum power:                     | -1.200 to 1.200 pu in steps of 0.001                                                |
| Pickup level accuracy:             | ±1% or ±0.001 pu, whichever is greater                                              |
| Hysteresis:                        | 2% or 0.001 pu, whichever is greater                                                |
| Pickup delay:                      | 0 to 600.00 s in steps of 0.01                                                      |
| Time accuracy:                     | ±3% or ±4 ms, whichever is greater                                                  |
| Operate time:                      | 50 ms                                                                               |
| <b>SPLIT PHASE PROTECTION</b>      |                                                                                     |
| Operating quantity:                | split phase CT current biased by generator load current                             |
| Pickup level:                      | 0.000 to 1.500 pu in steps of 0.001                                                 |
| Dropout level:                     | 97 to 98% of pickup                                                                 |
| Level accuracy:                    | ±0.5% of reading or ±1% of rated                                                    |
| Pickup delay:                      | 0.000 to 65.535 s in steps of 0.001                                                 |
| Time accuracy:                     | ±3% of ± cycles, whichever is greater                                               |
| Operate time:                      | < 5 cycles at 1.10 x pickup at 60Hz                                                 |
| <b>STATOR DIFFERENTIAL</b>         |                                                                                     |
| Pickup:                            | 0.050 to 1.00 pu in steps of 0.01                                                   |
| Slope 1/2:                         | 1 to 100% in steps of 1                                                             |
| Break 1:                           | 1.00 to 1.50 pu in steps of 0.01                                                    |
| Break 2:                           | 1.50 to 30.00 pu in steps of 0.01                                                   |
| Level accuracy:                    | ±2%                                                                                 |
| <b>SYNCHROCHECK</b>                |                                                                                     |
| Max voltage difference:            | 0 to 400000 V in steps of 1                                                         |
| Max angle difference:              | 0 to 100° in steps of 1                                                             |
| Max freq. difference:              | 0.00 to 2.00 Hz in steps of 0.01                                                    |
| Hysteresis for max. freq. diff.:   | 0.00 to 0.10 Hz in steps of 0.01                                                    |
| Dead source function:              | None, LV1 & DV2, DV1 & LV2, DV1 or DV2, DV1 xor DV2, DV1 & DV2 (L = Live, D = Dead) |
| Freq. Slip Maximum dF:             | 0.10 to 2.00 in steps of 0.01 Hz                                                    |
| Freq. Slip Minimum dF:             | 0.01 to 1.00 in steps of 0.01 Hz                                                    |
| Freq. Slip Close Breaker Time:     | 0.010 to 0.500 in steps of 0.001 s                                                  |

| PROTECTION                                      |                                                                                                                                   |
|-------------------------------------------------|-----------------------------------------------------------------------------------------------------------------------------------|
| <b>THERMAL MODEL</b>                            |                                                                                                                                   |
| Thermal overload curves:                        | Standard curve, FlexCurve, voltage dependent curve                                                                                |
| Standard Curve Time Multiplier:                 | 0.00 to 600.00 in steps of 0.01                                                                                                   |
| Thermal Overload Pickup:                        | pu = overload factor x FLA                                                                                                        |
| Overload (OF):                                  | 1.00 to 1.50 in steps of 0.001                                                                                                    |
| Standard Overload Curve:                        | trip time =                                                                                                                       |
|                                                 | $TD \times 2.2116623 \times \left( \frac{I_{motor}}{OF \times FLA} \right)^2 + 0.05054758 \times \frac{I_{motor}}{OF \times FLA}$ |
| Motor Rated Voltage:                            | 1 to 50000 V in steps of 1                                                                                                        |
| Thermal Motor Biasing:                          | Current unbalance, RTDs                                                                                                           |
| Thermal Model Update Rate:                      | 1 power cycle                                                                                                                     |
| Stopped/Running Time Cool Constants:            | 1 to 65000 min. in steps of 1                                                                                                     |
| Stopped/Running Time Cool Constants Decay:      | Exponential                                                                                                                       |
| Hot/Cold Safe Stall Ratio:                      | 0.01 to 1.00 in steps of 0.01                                                                                                     |
| Current Accuracy:                               | Per phase current inputs                                                                                                          |
| Current Source:                                 | True RMS                                                                                                                          |
| Timing Accuracy:                                | ± 100 ms or ± 2% whichever is greater                                                                                             |
| Timing Accuracy for Voltage Dependent Overload: | ± 100 ms or ± 4%, whichever is greater                                                                                            |
| <b>THIRD HARMONIC NEUTRAL UNDERVOLTAGE</b>      |                                                                                                                                   |
| Operating quantity:                             | 3rd harmonic of auxiliary undervoltage                                                                                            |
| Undervoltage:                                   |                                                                                                                                   |
| Pickup level:                                   | 0.001 to 3.000 pu in steps of 0.001                                                                                               |
| Dropout level:                                  | 102 to 103% of pickup                                                                                                             |
| Accuracy:                                       | ±2% of reading from 1 to 120V                                                                                                     |
| Power:                                          |                                                                                                                                   |
| Pickup level:                                   | 0.000 to 1.200 pu in steps of 0.001                                                                                               |
| Dropout level:                                  | 97 to 98% of pickup                                                                                                               |
| Accuracy:                                       | ±5% or ±0.01 pu, whichever is greater                                                                                             |
| Undervoltage Inhibit Level:                     | 0.000 to 3.000 pu in steps of 0.001 pu                                                                                            |
| Accuracy:                                       | ±0.5% of reading from 10 to 208V                                                                                                  |
| Pickup delay:                                   | 0 to 600.00 s in steps of 0.01                                                                                                    |
| Time accuracy:                                  | ±3% or ±20 ms, whichever is greater                                                                                               |
| Operate time:                                   | < 30 ms at 1.10 x pickup at 60 Hz                                                                                                 |
| <b>TRANSFORMER AGING FACTOR</b>                 |                                                                                                                                   |
| Operating quantity:                             | computed aging acceleration factor (pu)                                                                                           |
| Pickup level:                                   | 1 to 10 pu in steps of 0.1                                                                                                        |
| Pickup delay:                                   | 0 to 30000 min. in steps of 1                                                                                                     |
| <b>TRANSFORMER INSTANTANEOUS DIFFERENTIAL</b>   |                                                                                                                                   |
| Pickup level:                                   | 2.00 to 30.00 pu in steps of 0.01                                                                                                 |
| Dropout level:                                  | 97 to 98% of pickup                                                                                                               |
| Level accuracy:                                 | ±0.5% of reading or ±1% of rated (whichever is greater)                                                                           |
| Operate time:                                   | < 20 ms at 3 x pickup at 60 Hz                                                                                                    |
| <b>TRANSFORMER HOTTEST-SPOT TEMPERATURE</b>     |                                                                                                                                   |
| Operating quantity:                             | computed temperature in °C                                                                                                        |
| Pickup level:                                   | 50 to 300°C in steps of 1                                                                                                         |
| Dropout level:                                  | 1°C below pickup                                                                                                                  |
| Pickup delay:                                   | 0 to 30000 min. in steps of 1                                                                                                     |
| <b>TRANSFORMER LOSS OF LIFE</b>                 |                                                                                                                                   |
| Operating quantity:                             | computed accumulated transformer loss of life, in hours                                                                           |
| Pickup level:                                   | 0 to 500000 hours in steps of 1                                                                                                   |
| <b>TRANSFORMER PERCENT DIFFERENTIAL</b>         |                                                                                                                                   |
| Characteristic:                                 | Differential Restraint pre-set                                                                                                    |
| Number of zones:                                | 2                                                                                                                                 |
| Minimum pickup:                                 | 0.05 to 1.00 pu in steps of 0.001                                                                                                 |
| Slope 1 range:                                  | 15 to 100% in steps of 1%                                                                                                         |
| Slope 2 range:                                  | 50 to 100% in steps of 1%                                                                                                         |
| Kneepoint 1:                                    | 1.0 to 2.0 pu in steps of 0.0001                                                                                                  |
| Kneepoint 2:                                    | 2.0 to 30.0 pu in steps of 0.0001                                                                                                 |
| 2nd harmonic inhibit level:                     | 1.0 to 40.0% in steps of 0.1                                                                                                      |
| 2nd harmonic inhibit function:                  | Adaptive, Traditional, Disabled                                                                                                   |
| 2nd harmonic inhibit mode:                      | Per-phase, 2-out-of-3, Average                                                                                                    |
| 5th harmonic inhibit range:                     | 1.0 to 40.0% in steps of 0.1                                                                                                      |
| Operate times:                                  |                                                                                                                                   |
| Harmonic inhibits selected:                     | 20 to 30 ms                                                                                                                       |
| No harmonic inhibits selected:                  | 5 to 20 ms                                                                                                                        |
| Dropout level:                                  | 97 to 98% of pickup                                                                                                               |
| Level accuracy:                                 | ±0.5% of reading or ±1% of rated (whichever is greater)                                                                           |

| PROTECTION                                                                                     |                                                                                                                                                                                                                                               |
|------------------------------------------------------------------------------------------------|-----------------------------------------------------------------------------------------------------------------------------------------------------------------------------------------------------------------------------------------------|
| <b>TRIP OUTPUT</b>                                                                             |                                                                                                                                                                                                                                               |
| Collects trip and reclose input requests and issues outputs to control tripping and reclosing. |                                                                                                                                                                                                                                               |
| Communications timer delay:                                                                    | 0 to 65535 s in steps of 0.001                                                                                                                                                                                                                |
| Evolving fault timer:                                                                          | 0.000 to 65.535 s in steps of 0.001                                                                                                                                                                                                           |
| Timing accuracy:                                                                               | ±3% or 4 ms, whichever is greater                                                                                                                                                                                                             |
| <b>UNDERFREQUENCY</b>                                                                          |                                                                                                                                                                                                                                               |
| Minimum signal:                                                                                | 0.10 to 1.25 pu in steps of 0.01                                                                                                                                                                                                              |
| Pickup level:                                                                                  | 20.00 to 65.00 Hz in steps of 0.01                                                                                                                                                                                                            |
| Dropout level:                                                                                 | Pickup + 0.03 Hz                                                                                                                                                                                                                              |
| Level accuracy:                                                                                | ±0.01 Hz                                                                                                                                                                                                                                      |
| Time delay:                                                                                    | 0 to 65.535 s in steps of 0.001                                                                                                                                                                                                               |
| Timer accuracy:                                                                                | ±3% or 4 ms, whichever is greater                                                                                                                                                                                                             |
| <b>VOLTS PER HERTZ</b>                                                                         |                                                                                                                                                                                                                                               |
| Voltage:                                                                                       | Phasor only                                                                                                                                                                                                                                   |
| Pickup level:                                                                                  | 0.80 to 4.00 in steps of 0.01 pu V/Hz                                                                                                                                                                                                         |
| Dropout level:                                                                                 | 97 to 98% of Pickup                                                                                                                                                                                                                           |
| Level accuracy:                                                                                | ±0.02 pu                                                                                                                                                                                                                                      |
| Timing curves:                                                                                 | Definite Time; Inverse A, B, and C, FlexCurves A, B, C, and D                                                                                                                                                                                 |
| TD Multiplier:                                                                                 | 0.05 to 600.00 s in steps of 0.01                                                                                                                                                                                                             |
| Reset delay:                                                                                   | 0.0 to 1000.0 s in steps of 0.1                                                                                                                                                                                                               |
| Timing accuracy:                                                                               | ±3% or ± 4 ms (whichever is greater)                                                                                                                                                                                                          |
| <b>VT FUSE FAIL</b>                                                                            |                                                                                                                                                                                                                                               |
| Monitored parameters:                                                                          | V <sub>2</sub> , V <sub>1</sub> , I <sub>1</sub>                                                                                                                                                                                              |
| <b>WATTMETRIC ZERO-SEQUENCE DIRECTIONAL</b>                                                    |                                                                                                                                                                                                                                               |
| Measured Power:                                                                                | Zero-Sequence                                                                                                                                                                                                                                 |
| Number of Elements:                                                                            | 2                                                                                                                                                                                                                                             |
| Characteristic Angle:                                                                          | 0 to 360° in steps of 1                                                                                                                                                                                                                       |
| Minimum Power:                                                                                 | 0.001 to 1.20pu in steps of 0.001                                                                                                                                                                                                             |
| Pickup Level Accuracy:                                                                         | ±1% or ± 0.0025 pu, whichever is greater                                                                                                                                                                                                      |
| Pickup Delay:                                                                                  | Definite time (0 to 600.00 s in steps of 0.01), inverse time, or FlexCurve                                                                                                                                                                    |
| Inverse Time Multiplier:                                                                       | 0.01 to 2.00 s in steps of 0.01                                                                                                                                                                                                               |
| Time Accuracy:                                                                                 | ±3% or ±8 ms, whichever is greater                                                                                                                                                                                                            |
| Operate Time:                                                                                  | <30 ms at 60 Hz                                                                                                                                                                                                                               |
| <b>MONITORING</b>                                                                              |                                                                                                                                                                                                                                               |
| <b>DATA LOGGER</b>                                                                             |                                                                                                                                                                                                                                               |
| Number of channels:                                                                            | 1 to 16                                                                                                                                                                                                                                       |
| Parameters:                                                                                    | Any available analog actual value                                                                                                                                                                                                             |
| Sampling rate:                                                                                 | 15 to 3600000 ms in steps of 1                                                                                                                                                                                                                |
| Trigger:                                                                                       | Any FlexLogic operand                                                                                                                                                                                                                         |
| Mode:                                                                                          | Continuous or Triggered                                                                                                                                                                                                                       |
| Storage capacity:                                                                              | (NN is dependent on memory)                                                                                                                                                                                                                   |
| 1-second rate:                                                                                 | 01 channel for NN days<br>16 channels for NN days<br>01 channel for NN days<br>16 channels for NN days                                                                                                                                        |
| 60-minute rate:                                                                                |                                                                                                                                                                                                                                               |
| <b>EVENT RECORDER</b>                                                                          |                                                                                                                                                                                                                                               |
| Capacity:                                                                                      | 1024 events                                                                                                                                                                                                                                   |
| Time-tag:                                                                                      | to 1 microsecond                                                                                                                                                                                                                              |
| Triggers:                                                                                      | Any element pickup, dropout or operate<br>Digital input change of state<br>Digital output change of state<br>Self-test events                                                                                                                 |
| Data storage:                                                                                  | In non-volatile memory                                                                                                                                                                                                                        |
| <b>FAULT LOCATOR</b>                                                                           |                                                                                                                                                                                                                                               |
| Method:                                                                                        | Single-ended                                                                                                                                                                                                                                  |
| Maximum accuracy if:                                                                           | Fault resistance is zero or fault currents from all line terminals are in phase                                                                                                                                                               |
| Relay accuracy:                                                                                | ±1.5% (V > 10 V, I > 0.1 pu)                                                                                                                                                                                                                  |
| Worst-case accuracy:                                                                           | VT%error + (user data)<br>CT%error + (user data)<br>ZLine%error + (user data)<br>METHOD%error + (Chapter 6)<br>RELAY ACCURACY%error + (1.5%)                                                                                                  |
| <b>HIGH-IMPEDANCE FAULT DETECTION (HIZ)</b>                                                    |                                                                                                                                                                                                                                               |
| Detections:                                                                                    | Arc Suspected, Arc Detected, Downed Conductor, Phase Identification                                                                                                                                                                           |
| <b>OSCILLOGRAPHY</b>                                                                           |                                                                                                                                                                                                                                               |
| Maximum records:                                                                               | 64                                                                                                                                                                                                                                            |
| Sampling rate:                                                                                 | 64 samples per power cycle                                                                                                                                                                                                                    |
| Triggers:                                                                                      | Any element pickup, dropout or operate<br>Digital input change of state<br>Digital output change of state<br>Any FlexLogic operand<br>FlexLogic Equation<br>AC input channels<br>Element state<br>Digital input state<br>Digital output state |
| Data storage:                                                                                  | In non-volatile memory                                                                                                                                                                                                                        |
| <b>USER-PROGRAMMABLE FAULT REPORT</b>                                                          |                                                                                                                                                                                                                                               |
| Number of elements:                                                                            | 2                                                                                                                                                                                                                                             |
| Pre-fault trigger:                                                                             | any FlexLogic operand                                                                                                                                                                                                                         |
| Fault trigger:                                                                                 | any FlexLogic operand                                                                                                                                                                                                                         |
| Recorder quantities:                                                                           | 32 (any FlexAnalog value)                                                                                                                                                                                                                     |





# UR Technical Specifications

**OUTPUTS**  
**CONTROL POWER EXTERNAL OUTPUT (FOR DRY CONTACT INPUT)**  
**Capacity:** 100 mA DC at 48 V DC  
**Isolation:** ±300 Vpk  
**DCMA OUTPUTS**  
**Range:** -1 to 1 mA, 0 to 1 mA, 4 to 20 mA  
**Max. load resistance:** 12 k for -1 to 1 mA range  
 12 k for 0 to 1 mA range  
 600 for 4 to 20 mA range  
**Accuracy:** ±0.75% of full-scale for 0 to 1 mA range  
 ±0.5% of full-scale for -1 to 1 mA range  
 ±0.75% of full-scale for 0 to 20 mA range  
 100 ms

99% Settling time to a step change:  
 Isolation: 1.5 kV  
 Driving signal: any FlexAnalog quantity  
 Upper & lower limit for the driving signal:  
 -90 to 90 pu in steps of 0.001

**DIRECT OUTPUTS**  
 Output points: 32  
**FORM-A CURRENT MONITOR**  
 Threshold current: approx. 80 to 100 mA  
**FORM-A RELAY**  
 Make & carry for 0.2s: 30 A as per ANSI C37.90  
 Carry continuous: 6 A  
 Break at L/R of 40 ms: 1 A DC max. at 24 V  
 0.5 A DC max. at 48 V  
 0.3 A DC max. at 125 V  
 0.2 A DC max. at 250 V  
 < 4 ms  
 Silver alloy

**FORM-A VOLTAGE MONITOR**  
 Contact material: Silver alloy  
 Applicable voltage: approx. 15 to 250 V DC  
 Trickle current: approx. 1 to 2.5 mA

| INPUT VOLTAGE | IMPEDANCE   |             |
|---------------|-------------|-------------|
|               | 2W RESISTOR | 1W RESISTOR |
| 250 V DC      | 20 K        | 50K         |
| 120 V DC      | 5 K         | 2 K         |
| 48 V DC       | 2 K         | 2 K         |
| 24 V DC       | 2 K         | 2 K         |

**FORM-C AND CRITICAL FAILURE RELAY**  
 Make & carry for 0.2 s: 30 A  
 Carry continuous: 8 A  
 Break at L/R of 40 ms: 0.25 A DC max. at 48 V  
 0.10 A DC max. at 125 V  
 < 8 ms  
 Silver alloy  
**FAST FORM-C RELAY**  
 Make & carry: 0.1 A max. (resistive load)  
 Minimum load impedance:  
 Operate time: < 0.6 ms  
 Internal Limiting  
 Resistor: 100, 2

**IRIG-B OUTPUT**  
 Amplitude: 10 V peak-peak RS485 level  
 Maximum load: 100 ohms  
 Time delay: 1 ms for AM input  
 40 µs for DC-shift input  
 2 kV

**LATCHING RELAY**  
 Make & carry for 0.2 s: 30 A as per ANSI C37.90  
 Carry continuous: 6 A  
 Break at L/R of 40 ms: 0.25 A DC max.  
 Operate time: < 4 ms  
 Contact material: Silver alloy  
 Control: separate operate and reset inputs  
 Control mode: operate-dominant or reset-dominant

**REMOTE OUTPUTS (IEC 61850 GSSE)**  
 Standard output points: 32  
 User output points: 32  
**SOLID-STATE RELAY**  
 Operate & release time: <100 µs  
 Maximum voltage: 265 V DC  
 Maximum continuous current: 5 A at 45°C; 4 A at 65°C  
 Make & carry for 0.2 s: as per ANSI C37.90  
 For 0.3s: 300 A

Breaking capacity:

|                                 | IEC 647-5/UL508                                                  | UTILITY APPLICATION (AUTORECLOSE SCHEME)             | INDUSTRIAL APPLICATION              |
|---------------------------------|------------------------------------------------------------------|------------------------------------------------------|-------------------------------------|
| Operations/interval             | 5000 ops<br>1 s-On, 9 s-Off<br>= 1000 ops<br>0.5 s-On, 0.5 s-Off | 5 ops/<br>2 s-On,<br>0.2 s-Off<br>within 1<br>minute | 10000 ops/<br>0.2 s-On,<br>30 s-Off |
| Break capability (0 to 250 VDC) | 3.2 A<br>L/R=10 ms                                               | 10 A<br>L/R=40 ms                                    | 10 A<br>L/R=40 ms                   |
|                                 | 1.6 A<br>L/R=20 ms                                               |                                                      |                                     |
|                                 | 0.8 A<br>L/R=40 ms                                               |                                                      |                                     |

**COMMUNICATIONS**  
**RS232**  
**Front port:** 19.2 kbps, Modbus® RTU, DNP 3.0  
**RS485**  
**1 or 2 rear ports:** Up to 115 kbps, Modbus® RTU, DNP 3.0 isolated together at 36 Vpk  
 1200 m  
 Isolation: 2 kV  
**ETHERNET PORT**  
 Up to Three 100Base-F: 1310 nm, multi-mode, supports half-duplex/full-duplex fiber optic with ST or LC connector  
 10 dB  
 -14 dBm

**Power budget:**  
**Max optical input power:** -20 dBm  
**Max optical output power:** -30 dBm  
**Receiver sensitivity:** 2 km  
**Typical distance:** Hot-standby, PRP  
**Redundancy:** Twisted pair, RJ45 connector  
 Up to three 10/100BaseT: SNTP Clock (redundant) synchronization error <10 ms (typical)

**PROTOCOLS**

|           | RS232 | RS485 | 10BaseF | 10BaseT | 100BaseT |
|-----------|-------|-------|---------|---------|----------|
| IEC 61850 |       |       | *       | *       | *        |
| DNP 3.0   | *     | *     | *       | *       | *        |
| Modbus    | *     | *     | *       | *       | *        |
| IEC104    |       |       | *       | *       | *        |
| EGD       |       |       | *       | *       | *        |

**INTER-RELAY COMMUNICATIONS SHIELDED TWISTED-PAIR INTERFACE OPTIONS**

| INTERFACE TYPE | TYPICAL DISTANCE |
|----------------|------------------|
| RS422          | 1200m            |
| G.703          | 100m             |

\* NOTE: RS422 distance is based on transmitter power and does not take into consideration the clock source provided by the user.

**LINK POWER BUDGET**

| EMITTER, FIBER TYPE      | TRANSMIT POWER | RECEIVED SENSITIVITY | POWER BUDGET |
|--------------------------|----------------|----------------------|--------------|
| 820nm LED Multimode      | -20dBm         | -30dBm               | 10dB         |
| 1300 nm LED Multimode    | -21dBm         | -30dBm               | 9dB          |
| 1300 nm ELED Multimode   | -21dBm         | -30dBm               | 9dB          |
| 1300 nm Laser Singlemode | -1dBm          | -30dBm               | 29dB         |
| 1500 nm Laser Singlemode | +5dBm          | -30dBm               | 35dB         |

\* NOTE: These power budgets are calculated from the manufacturers' worst-case transmitter power and worst-case receiver sensitivity.

**MAXIMUM OPTICAL INPUT POWER**

| EMITTED, FIBER TYPE       | MAX. OPTICAL INPUT POWER |
|---------------------------|--------------------------|
| 820 nm LED, Multimode     | -7.6 dBm                 |
| 1300 nm LED, Multimode    | -11 dBm                  |
| 1300 nm ELED, Singlemode  | -14 dBm                  |
| 1300 nm Laser, Singlemode | -14 dBm                  |
| 1500 nm Laser, Singlemode | -14 dBm                  |

**TYPICAL LINK DISTANCE**

| EMITTED TYPE  | FIBER TYPE | CONNECTOR TYPE | TYPICAL DISTANCE |
|---------------|------------|----------------|------------------|
| 820 nm LED    | Multimode  | -7.6 dBm       | 1.65 km          |
| 1300 nm LED   | Multimode  | -11 dBm        | 3.8 km           |
| 1300 nm ELED  | Singlemode | -14 dBm        | 11.4 km          |
| 1300 nm Laser | Singlemode | -14 dBm        | 64 km            |
| 1500 nm Laser | Singlemode | -14 dBm        | 105 km           |

**INTER-RELAY COMMUNICATIONS**  
 \* Note: Typical distances listed are based on the following assumptions for system loss. Actual losses will vary from one installation to another, the distance covered by your system may vary.

**CONNECTOR LOSSES (TOTAL OF BOTH ENDS)**

| ST connector        | 2dB                                               |
|---------------------|---------------------------------------------------|
| <b>FIBER LOSSES</b> |                                                   |
| 820 nm multimode    | 3 dB/km                                           |
| 1300 nm multimode   | 1 dB/km                                           |
| 1300 nm singlemode  | 0.35 dB/km                                        |
| 1550 nm singlemode  | 0.25 dB/km                                        |
| Splice losses:      | One splice every 2 km, at 0.05 dB loss per splice |

**SYSTEM MARGIN**  
 3 dB additional loss added to calculations to compensate for all other losses.

Compensate difference in transmitting and receiving (channel asymmetry) channel delays using GPS satellite clock: 10 ms

**POWER SUPPLY**  
**LOW RANGE**  
**Nominal DC voltage:** 24 to 48 V at 3 A  
**Min/max DC voltage:** 20 / 60 V  
 \* NOTE: Low range is DC only.  
**HIGH RANGE**  
**Nominal DC voltage:** 125 to 250 V at 0.7 A  
**Min/max DC voltage:** 88 / 300 V  
**Nominal AC voltage:** 100 to 240 V at 50/60 Hz, 0.7 A  
**Min/max AC voltage:** 88 / 265 V at 25 to 100 Hz  
**ALL RANGES**  
**Volt withstand:** 2 x Highest Nominal Voltage for 10 ms  
**Voltage loss hold-up:** 50 ms duration at nominal  
**Power consumption:** Typical = 15 VA; Max. = 30 VA  
**INTERNAL FUSE RATINGS**  
**Low range power supply:** 8 A / 250 V  
**High range power supply:** 4 A / 250 V  
**INTERRUPTING CAPACITY**  
**AC:** 100 000 A RMS symmetrical  
**DC:** 10 000 A  
**Hold up time:** 200 ms

**TYPE TESTS**  
**Electrical fast transient:** ANSI/IEEE C37.90.1  
 IEC 61000-4-4  
 IEC 60255-22-4  
**Oscillatory transient:** ANSI/IEEE C37.90.1  
 IEC 61000-4-12  
**Insulation resistance:** IEC 60255-5  
**Dielectric strength:** IEC 60255-6  
 ANSI/IEEE C37.90  
**Electrostatic discharge:** EN 61000-4-2  
**Surge immunity:** EN 61000-4-5  
**RFI susceptibility:** ANSI/IEEE C37.90.2  
 IEC 61000-4-3  
 IEC 60255-22-3  
 Ontario Hydro C-5047-77  
**Conducted RFI:** IEC 61000-4-6  
**Voltage dips/interruptions/variatioins:** IEC 61000-4-11  
 IEC 60255-11  
**Power frequency magnetic field immunity:** IEC 61000-4-8  
 IEC 60255-21-1  
**Vibration test (sinusoidal):** IEC 60255-21-2  
**Shock and bump:** Type test report available upon request.

**PRODUCTION TESTS**  
**THERMAL**  
 Products go through an environmental test based upon an accepted quality level (AQL) sampling process  
**ENVIRONMENTAL**  
**OPERATING TEMPERATURES**  
**Cold:** IEC 60028-2-1, 16 h at -40°C  
**Dry Heat:** IEC 60028-2-2, 16 h at +85°C  
**OTHER**  
**Humidity(noncondensing):** IEC 60068-2-30, 95%, Variant 1, 6days.  
 Up to 2000 m  
**Altitude:** Up to 2000 m  
**Installation Category:** II  
**APPROVALS**  
**UL Listed for the USA and Canada**  
 Manufactured under an ISO9000 registered system.  
 LVD 73/23/EEC: IEC 1010-1  
 EMC 81/336/EEC: EN 50081-2, EN 50082-2



IEC is a registered trademark of Commission Electrotechnique Internationale. IEEE is a registered trademark of the Institute of Electrical Electronics Engineers, Inc. Modbus is a registered trademark of Schneider Automation. NERC is a registered trademark of North American Electric Reliability Council. NIST is a registered trademark of the National Institute of Standards and Technology.

GE, the GE monogram, MultiIn, FlexLogic, EnerVista and CyberSentry are trademarks of General Electric Company.

GE reserves the right to make changes to specifications of products described at any time without notice and without obligation to notify any person of such changes.