

Multilin C60



Breaker Monitoring and Control for Substation and Industrial Automation

The Multilin™ C60 Breaker Protection System is a substation hardened controller that provides a complete integrated package for the protection, control, and monitoring of circuit breakers. The C60 supports dual-breaker busbar configurations such as breaker-and-a-half or ring bus arrangements. Signals from up to 4 sets of CT's can be brought into the C60 via conventional wiring or process bus for internal summation, which is advantageous by still having the individual currents available for metering and the additional protection elements that operate on individual currents.

The C60 provides fast and deterministic execution of programmable logic and extensive I/O options that are necessary for substation automation applications. All of the necessary control logic functions are available for creating automated breaker control schemes, such as the popular main-tie-main scheme using a single C60 device.

Using high-speed peer-to-peer communications for inter-device messaging, the C60 can also accept breaker opening, closing and lock-out commands from other devices at a fraction of the cost of hardwiring these signals.

Key Benefits

- Complete breaker control, protection, monitoring and integration in a single platform
- Advanced automation capabilities for providing customized protection and control solutions
- Modular hardware architecture allows for flexibility in device configurations to cover most breaker applications
- An integrated large, full color display, provides real-time visualization and control of the protected bay, via a bay mimic as well as annunciator functionality and graphical visualization of phasors
- Advanced IEC 61850 Ed. 1 and Ed. 2 certified implementation, complete settings via SCL files and comprehensive process bus support (IEC 61850-9-2LE or IEC 61869 or IEC 61850-9-2 Hardfiber) ensures interoperability, device managing optimization and reduced cost of ownership
- Routable GOOSE (R-GOOSE) enables GOOSE messages going beyond the substation, which enables wide area protection and control applications
- Increased network availability via failover time reduced to zero through IEC® 62439-3 "PRP" support
- Supports latest edition of waveform capture (COMTRADE 2013) simplifying fault records management

Applications

- Stand-alone breaker monitoring and control
- Automatic bus transfer scheme using a single device
- Multiple breaker configuration control including breaker-and-a-half and ring bus
- As part of a distributed bay controller

Protection and Control

- Breaker failure & Synchronism check
- Autoreclose and open pole detector
- Phase, neutral and auxiliary overvoltage
- Sensitive directional power & dual breaker control
- High density inputs/outputs to support the control of many switchyard assets - all from one powerful device
- Integrated large, full color display, for real-time visualization and control of the protected bay

Advanced Communications

- 3 independent Ethernet ports for simultaneous & dedicated network connections with IEEE 1588 support
- Phasor Measurement Unit (Synchrophasor) according to IEEE® C37.118 (2011) and IEC 61850-90-5
- IEC 61850-9-2LE/IEC 61869 networked or IEC61850-9-2 Hardfiber process bus support

Cyber Security

- CyberSentry™ provides high-end cyber security aligned to industry standards and services (NERC® CIP, AAA, Radius, RBAC, Syslog)

Monitoring & Metering

- P & M Class Synchrophasors of voltage, current and sequence components
- Fault Locator
- Advanced recording capabilities with high-capacity event recorder, configurable and extended waveform capture and data logger
- Metering: current, voltage, power, energy, frequency, and harmonics



Protection and Control

As part of the UR family of Protection & Control devices, the Multilin C60 Breaker Protection System offers a high degree of modularity in its design and functionality, providing superior performance while meeting the toughest requirements of the marketplace.

Advanced protection and control features of this relay includes:

Breaker Failure

The breaker failure functions included in the C60 are available to detect breaker failure conditions for both single and three-pole tripping schemes. The C60 provides two independent breaker failure functions, and all of the current source inputs, digital inputs and digital outputs need to perform breaker failure functions on dual breaker schemes, such as breaker-and-a-half or ring bus arrangements. Breaker failure initiation and transfer tripping signals can be done using hardwired contacts or through communications (IEC 61850 and direct I/O).

Autorecloser

The C60 provides multi-shot autoreclosing on all types of faults for single or three-pole applications with independent dead time for each shot. The protection settings can be changed between shots (typical application being an accelerated zone 1 extension scheme). Autoreclosure can also be dynamically blocked by user-programmable logic. Four different autoreclose modes are available, enabling users

C60 - Protection, Metering, Monitoring and Control

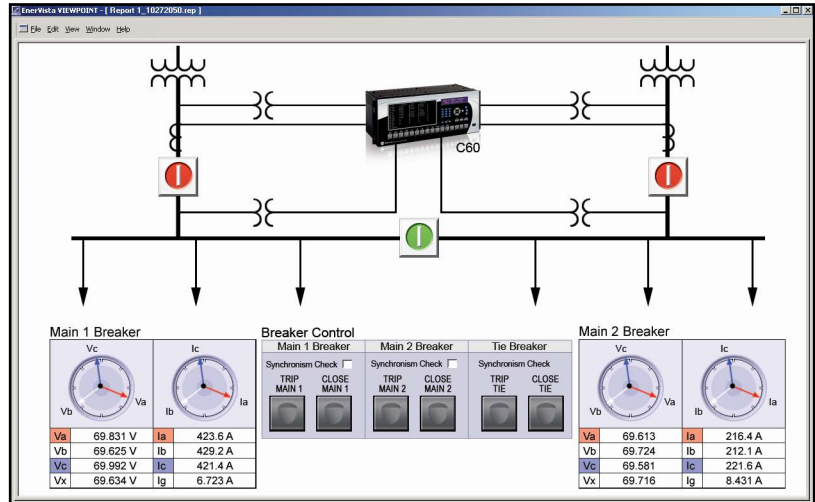

The C60 is the single point for protection, control, metering, and monitoring in one integrated device that can easily be connected directly into DCS or SCADA monitoring and control systems like Viewpoint Monitoring as shown.

to select the reclosure mode to suit specific applications. The autoreclose modes can be dynamically changed by any internal FlexLogic™ digital operand, allowing flexibility with changing system conditions.

Synchrocheck

The C60 provides ten synchrocheck elements that monitor voltage difference, phase angle difference and slip frequency taking the CB closing time into account to ensure proper breaker closure as per user requirements. Any of the ten synchrocheck

elements can be dynamically blocked or unblocked by other elements or user logic, allowing coordination with other C60 protection settings and groups. The C60 provides additional enhancements in synchronizing by checking dead source conditions for synchronism bypass under these conditions.

Overcurrent and Thermal Elements

Overcurrent protection is delivered through instantaneous and time overcurrent elements available for phase, neutral, ground and sensitive

Functional Block Diagram

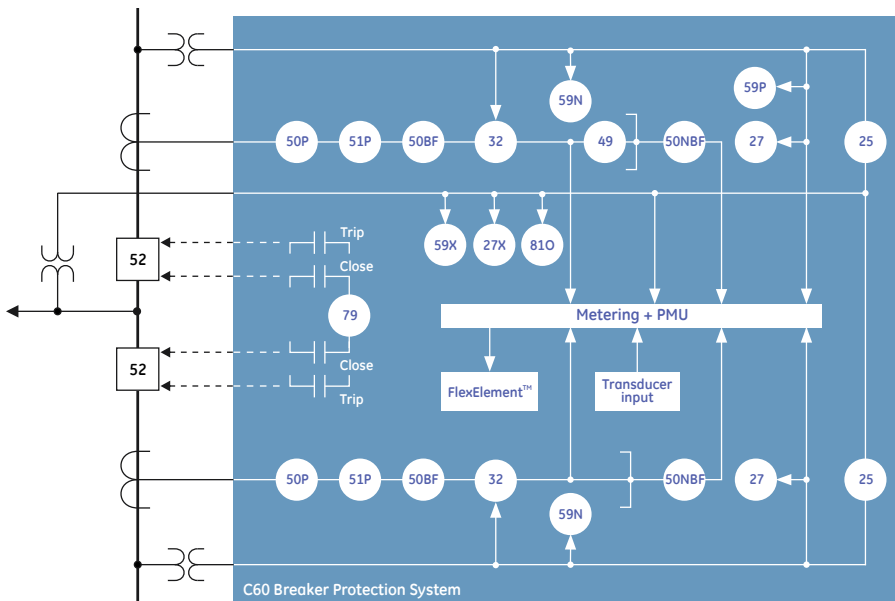

ANSI® Device Numbers & Functions

DEVICE NUMBER	FUNCTION
25	Synchrocheck
27P	Phase Undervoltage
27X	Auxiliary Undervoltage
32	Sensitive Directional Power
49	Thermal Overload Protection
50BF	Breaker Failure
50DD	Disturbance Detector
50G	Ground Instantaneous Overcurrent
50N	Neutral Instantaneous Overcurrent
50N BF	Neutral Instantaneous Overcurrent, Breaker Failure
50P	Phase Instantaneous Overcurrent
51G	Ground Time Overcurrent
51N	Neutral Time Overcurrent
51P	Phase Time Overcurrent
52	AC Circuit Breaker
59N	Neutral Overvoltage
59P	Phase Overvoltage
59X	Auxiliary Overvoltage
79	Autoreclose
81O	Overfrequency
	Harmonic/Inrush detection

ground protection. Most of the standard protection curves are provided. Thermal overload elements as per the IEC 255-8 standard are also available.

Sensitive Directional Power

Two separate directional power elements are provided to detect reverse and low forward power conditions for use in IEEE 1547 DG interconnection anti-islanding protection.

Breaker Control

The C60 allows for control of up to two breakers through commands given to it from either local or remote users. The C60 front panel can have 16 user-configurable pushbuttons that can be used to select and operate the breaker functions. Each button can be customized and labeled for easy operator identification. The C60 can also accept breaker operation commands from remote users through one of the many available communication protocols including Modbus, DNP 3.0, IEC 61850, and IEC 60870-5-104.

Harmonic/Inrush detection

The Harmonic detection element monitors the selected 2nd to 5th harmonic or Total Harmonics Distortion (THD), which is present in the phase currents. The relay provides six identical Harmonic Detection elements.

During transformer energization or motor starts, the inrush current present in phase currents can impact some sensitive elements, such as negative sequence overcurrent. Therefore, the ratio of the second harmonic to the fundamental magnitude per phase is monitored, while exceeding the settable pickup level, an operand is asserted, which can be used to block such sensitive elements.

IEC 61869 and 61850-9-2LE Process Bus

Three UR process bus modules enable communicating to Merging Units “MU” that comply to either IEC 61869 standard or IEC 61850-9-2LE technical report. MUs connect to the primary asset and translate analog signals and digital status/commands to standard sample values “SV” data and GOOSE messages.

Flexibility for connecting to different network size and topology is granted through 100Mbps and/or 1Gbps Ethernet port support, plus IEC 62439 PRP or HSR standard redundancy, plus Star, Ring and Point-to-point network support.

For time synchronization purposes, this Process bus module can become an IEEE 1588 slave clock (61850-9-3 profile) or a 1588 Grand Master

FlexLogic Designer

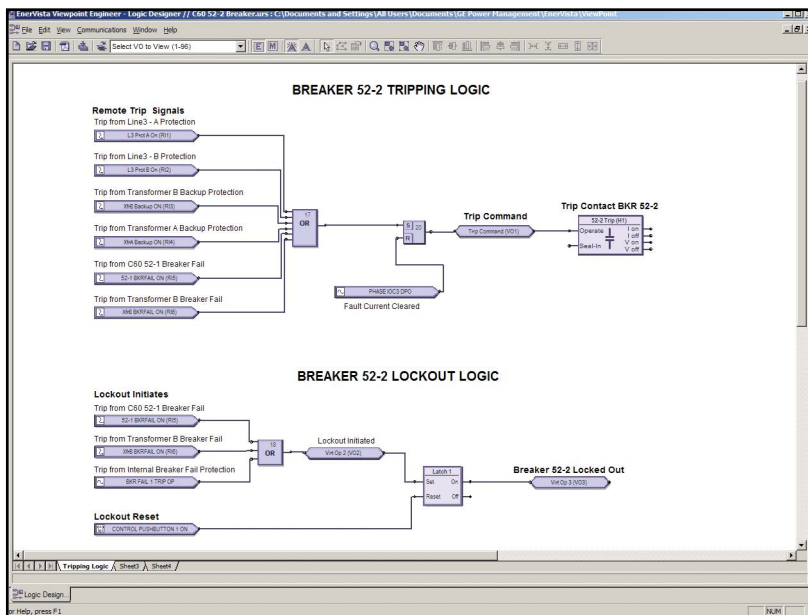

FlexLogic allows for the creation of customized C60 breaker control schemes, including the receipt of trip and close commands from other devices, and the creation of logic to replace the need for external lockout relays.

Topologies:

PRP Start
Hot-Stanby



Station Bus



Integrated Station and Process bus (available)

Topologies:

HSR ring
PRP start
P-2-P Process Bus



Process Bus:
IEC 61850-9-2LE or 61869* SV
IEEE 1588 Grand Master or slave 61850-9-1 GOOSE

Merging units

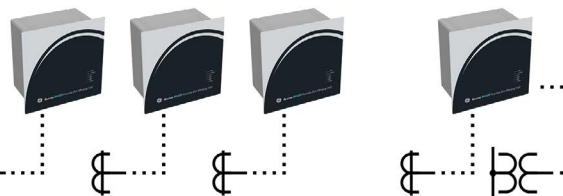

Conventional or Optical CT/VTs

clock which removes the need of external time sources connected to the process bus network.

Customers who may not be using GE MU devices, could use MU from other vendors. Interoperability with MU from other vendors is expected when they comply to the mentioned standards.

IEC 61850-9-2 HardFiber Process Bus

The IEC 61850 Process Bus module is designed to interface with the GE Multilin HardFiber System, allowing bi-directional IEC 61850 fiber optic communications. The HardFiber System is designed to integrate seamlessly with existing Universal Relay (UR) applications, including protection functions, FlexLogic, metering and communications.

The GE Multilin HardFiber System offers the following benefits:

- Communicates using open standard IEC 61850 messaging
- Drastically reduces P&C design, installation and testing labor by eliminating individual copper terminations
- Integrates with existing C60's by replacing traditional CT/VT inputs with the IEC 61850 Process Bus module
- Does not introduce new cyber security concerns

Visit the HardFiber System product page on the GE Multilin web site for more details.

Advanced Automation

The C60 incorporates advanced automation features including powerful FlexLogic programmable logic, communication, and SCADA capabilities that far surpass what is found in the average breaker relay or controller. The C60 integrates seamlessly with other UR relays for complete breaker management including reclosing, load shedding, and synchronism applications.

FlexLogic

FlexLogic is the powerful UR-platform programming logic engine that provides the ability to create customized protection and

control schemes, minimizing the need and associated costs of auxiliary components and wiring. With 1024 lines of FlexLogic, the C60 can be programmed to provide the required logic for performing complete breaker control in schemes that may include simple single breaker management, equipment backup protection as well as sophisticated automatic transfer schemes.

Scalable Hardware

The C60 is available with a multitude of I/O configurations to suit the most demanding application needs. The expandable modular design allows for easy configuration and future upgrades.

- Multiple CT/VT configurations allow for the implementation of many different schemes, including single and dual breaker applications
- Flexible, modular high density I/O covering a broad range of input signals and tripping schemes
- RTDs and DCmA inputs are available to monitor equipment parameters such as temperature and pressure

Monitoring and Metering

The C60 includes high accuracy metering and recording for all AC signals. Voltage, current, and power metering are built into the relay as a standard feature. Current and voltage

parameters are available as total RMS magnitude, and as fundamental frequency magnitude and angle.

Fault and Disturbance Recording

The advanced disturbance and event recording features within the C60 can significantly reduce the time needed for postmortem analysis of power system events and the creation of regulatory reports. Recording functions include:

- Sequence of Event (SOE)
 - 1024 time stamped events
- Oscillography
 - Supports IEEE C37.111-1999/2013, IEC 60255-24 Ed 2.0 COMTRADE standard
 - 128 digital & up to 56 analog channels
 - Events up to 45s in length
- Data Logger and Disturbance Recording
 - 16 channels up to 1 sample/cycle/channel
- Fault Reports
 - Powerful summary report of pre-fault and fault values

The very high sampling rate and large amounts of storage space available for data recording in the C60 can eliminate the need for installing costly stand-alone recording equipment.

Advanced Device Health Diagnostics

The C60 performs comprehensive device health diagnostic tests at startup and continuously

Power System Troubleshooting

The C60 contains tools that allow for the early detection of impending breaker problems and allow for maintenance to be performed before serious damage occurs.



Triggering a waveform on each breaker operation can identify changes in the length of time each part or mechanism in the breaker takes to perform its function.

• **Breaker Latch Release Time:**

Indicates how long it took for the breaker latch to release from the time the trip coil was energized by the relay.

• **Arc Extinguish Time:**

Indicates the length of time that was required for the breaker to extinguish the arc and finally clear the fault.

• **Breaker Mechanism Travel Time:**

Indicates time interval required for the breaker mechanism to travel to its rest position.

during run-time to test its own major functions and critical hardware. These diagnostic tests monitor for conditions that could impact security and availability of protection, and present device status via SCADA communications and front panel display. Providing continuous monitoring and early detection of possible issues help improve system uptime.

- Comprehensive device health diagnostic performed at startup
- Monitors the CT/VT input circuitry to validate the integrity of all signals

Cyber Security – CyberSentry UR

CyberSentry™ is a software option that delivers wide range of cyber security features that help customers to comply with NERC CIP, NIST® IR 7628, IEC 62351 and IEC 62443 cyber security requirements and standards. Additionally secure FW upgrade is granted through UR Setup's digital signature validation capabilities. This software option delivers the following core features:

AAA Server Support (Radius/LDAP)

Enables integration with centrally managed authentication and accounting of all user activities and uses modern industry best practices and standards that meet and exceed NERC CIP requirements for authentication and password management.

Role Based Access Control (RBAC)

Efficiently administrate users and roles within UR devices. The new and advanced access functions allow users to configure up to five roles for up to eight configurable users with independent passwords. The standard "Remote Authentication Dial In User Service" (Radius) is used for authentication.

Event Recorder (Syslog for SEM)

Capture all cyber security related events within a SOE element (login, logout, invalid password attempts, remote/local access, user in session, settings change, FW update, etc), and then serve and classify data by security level using standard Syslog data format. This will enable integration with established SEM (Security Event Management) systems.

Communications

The C60 provides advanced communications technologies for remote data and engineering access, making it easy and flexible to use and integrate into new and existing infrastructures. Direct support for fiber optic Ethernet provides high-bandwidth communications allowing for low-latency controls and high-speed file transfers of relay fault and event record information. The available three independent Ethernet ports, redundant Ethernet option and the embedded managed Ethernet switch provide the means to create fault tolerant

communication architectures in an easy, cost-effective manner without the need for intermediary communication hardware.

The C60 supports the most popular industry standard protocols enabling easy, direct integration into DCS and SCADA systems.

- IEC 61850 Ed. 1 and Ed. 2 Station Bus, IEC 61850-2-2LE / IEC 61869 networked or IEC 61850-9-2 HardFiber Process Bus, and IEC 61850-90-5 PMU over GOOSE support
- DNP 3.0 (serial & TCP/IP)
- Ethernet Global Data (EGD)
- IEC 60870-5-103 and IEC 60870-5-104
- Modbus RTU, Modbus TCP/IP
- HTTP, TFTP, SFTP and MMS file transfer
- IEEE1588 and redundant SNTP for time synchronization
- PRP as per IEC 62439-3
- IEC61850 GOOSE, Routable GOOSE and legacy UCA fixed GOOSE

Interoperability with Embedded IEC 61850 Ed. 1 and Ed. 2

The new IEC 61850 implementation in the UR Family positions GE as an industry leader in this standard.

- Implements, user selectable, Ed. 1 and Ed. 2 of the standard across the entire UR Family
- Provides full relay setting management via standard SCL files (ICD, CID and IID)
- Enables automated relay setting management using 3rd party tools through standard file transfer services (MMS and SFTP)
- Increases the number of Logical Devices and data mapped to them, GOOSE messages from up to 64 remote devices, and reports to support different organizational needs for data transfer and reduce dependency on generic logical nodes
- Configures GE Systems based on IEC 61850 using universal 3rd party tools
- Multicast IEEE C37.118 synchrophasor data between PMU and PDC devices using IEC 91850-90-5
- R-GOOSE enable customer to send GOOSE messages beyond the substation, which enables WAPC and more cost effective communication architectures for wide area applications

Simplifying Fault and Disturbance Analysis

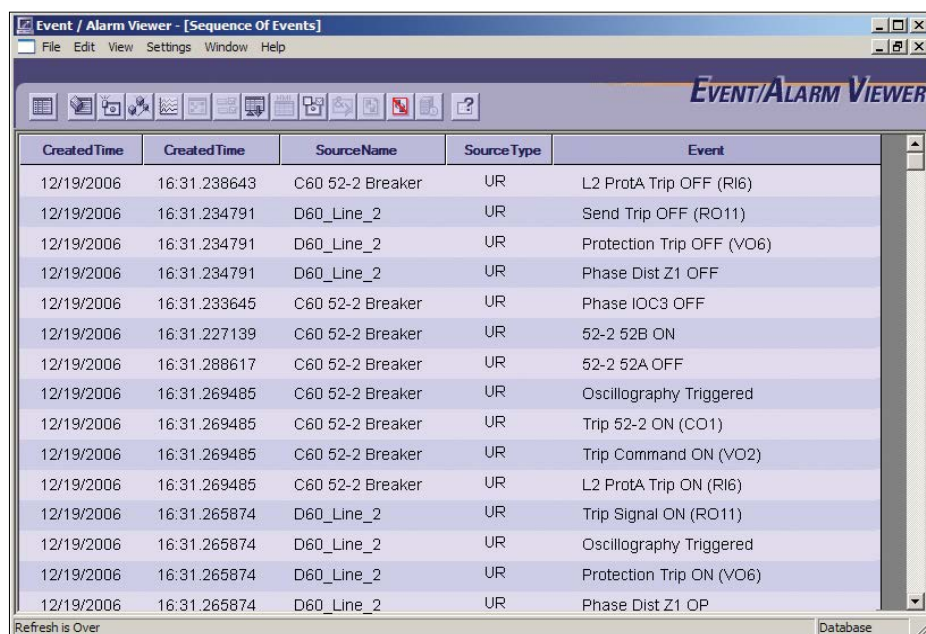

Created Time	CreatedTime	SourceName	Source Type	Event
12/19/2006	16:31.238643	C60 52-2 Breaker	UR	L2 ProtA Trip OFF (RI6)
12/19/2006	16:31.234791	D60_Line_2	UR	Send Trip OFF (RO11)
12/19/2006	16:31.234791	D60_Line_2	UR	Protection Trip OFF (VO6)
12/19/2006	16:31.234791	D60_Line_2	UR	Phase Dist Z1 OFF
12/19/2006	16:31.233645	C60 52-2 Breaker	UR	Phase IOC3 OFF
12/19/2006	16:31.227139	C60 52-2 Breaker	UR	52-2 52B ON
12/19/2006	16:31.288617	C60 52-2 Breaker	UR	52-2 52A OFF
12/19/2006	16:31.269485	C60 52-2 Breaker	UR	Oscillography Triggered
12/19/2006	16:31.269485	C60 52-2 Breaker	UR	Trip 52-2 ON (CO1)
12/19/2006	16:31.269485	C60 52-2 Breaker	UR	Trip Command ON (VO2)
12/19/2006	16:31.269485	C60 52-2 Breaker	UR	L2 ProtA Trip ON (RI6)
12/19/2006	16:31.265874	D60_Line_2	UR	Trip Signal ON (RO11)
12/19/2006	16:31.265874	D60_Line_2	UR	Oscillography Triggered
12/19/2006	16:31.265874	D60_Line_2	UR	Protection Trip ON (VO6)
12/19/2006	16:31.265874	D60_Line_2	UR	Phase Dist Z1 OP

The events recorded in multiple GE devices can be collected and merged into a single station-wide SOE record to simplify the tracking of substation operations.

Direct I/O Messaging

Direct I/O allows for the sharing of high-speed digital information between multiple UR relays via direct back-to-back connections or multiplexed through a standard DS0 multiplexer channel bank. Regardless of the connection method, direct I/O provides continuous real-time channel monitoring that supplies diagnostics information on channel health.

Direct I/O provides superior relay-to-relay communications that can be used in advanced interlocking, generation rejection and other special protection schemes.

- Communication with up to 16 UR relays in single or redundant rings rather than strictly limited to simplistic point-to-point configurations between two devices
- Connect to standard DS0 channel banks through standard RS422, G.703 or IEEE C37.94 interfaces or via direct fiber optic connections
- No external or handheld tester required to provide channel diagnostic information

LAN Redundancy

Substation LAN redundancy has been traditionally accomplished by reconfiguring the active network topology in case of failure. Regardless of the type of LAN architecture (tree, mesh, etc), reconfiguring the active LAN requires time to switchover, during which the LAN is unavailable. UR devices deliver redundancy as specified by PRP-IEC 62439-3, which eliminates the dependency on LAN reconfiguration and the associated switchover time. The UR becomes a dual attached node that transmits data packets over both main and redundant networks simultaneously, so in case of failure, one of the data packets will reach the receiving device with no time delay.

Multi-Language

UR devices support multiple languages: English, French, Russian, Chinese, Turkish, German, Polish and Japanese. These language options are available on the front panel, in the EnerVista setup software, and in the product manuals. Easily switch between English and an additional language on the local displays without uploading new firmware.

EnerVista Software

The EnerVista suite is an industry-leading set of software programs that simplifies every aspect of using the C60 relay. The EnerVista suite provides all the tools to monitor the status of the protected asset, maintain the relay, and

integrate information measured by the C60 into DCS or SCADA monitoring systems. Convenient COMTRADE and SOE viewers are an integral part of the UR setup software included with every UR relay, to carry out postmortem event analysis to ensure proper protection system operation.

EnerVista Launchpad

EnerVista Launchpad is a powerful software package that provides users with all of the setup and support tools needed for configuring and maintaining GE Multilin products. The setup software within Launchpad allows for the configuration of devices in real-time by communicating using serial, Ethernet, or modem connections, or offline by creating setting files to be sent to devices at a later time. Included in Launchpad is a document archiving and management system that ensures critical documentation is up-to-date and available when needed. Documents made available include:

- Manuals
- Wiring Diagrams
- Application Notes
- FAQ's
- Guideform Specifications
- Service Bulletins
- Brochures

Viewpoint Monitoring

Viewpoint Monitoring is a simple-to-use and full-featured monitoring and data recording software package for small systems. Viewpoint Monitoring provides a complete HMI package with the following functionality:

- Plug-&-Play Device Monitoring
- System Single-Line Monitoring & Control
- Annunciator Alarm Screens
- Trending Reports
- Automatic Event Retrieval
- Automatic Waveform Retrieval

User Interface

The C60 front panel provides extensive local HMI capabilities. The local display is used for monitoring, status messaging, fault diagnosis, and device configuration. User-configurable messages that combine text with live data can be displayed when user-defined conditions are met.

A 7" color, graphic HMI is optionally available that allows users to have customizable bay diagrams with local monitoring of status, values and control functionality. The alarm annunciator panel provides the configuration of up to 96 signals (alarms and status) with full text description.

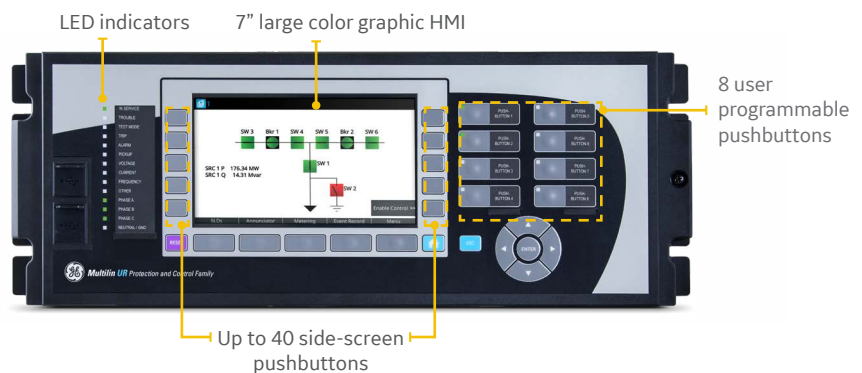

Typical Wiring

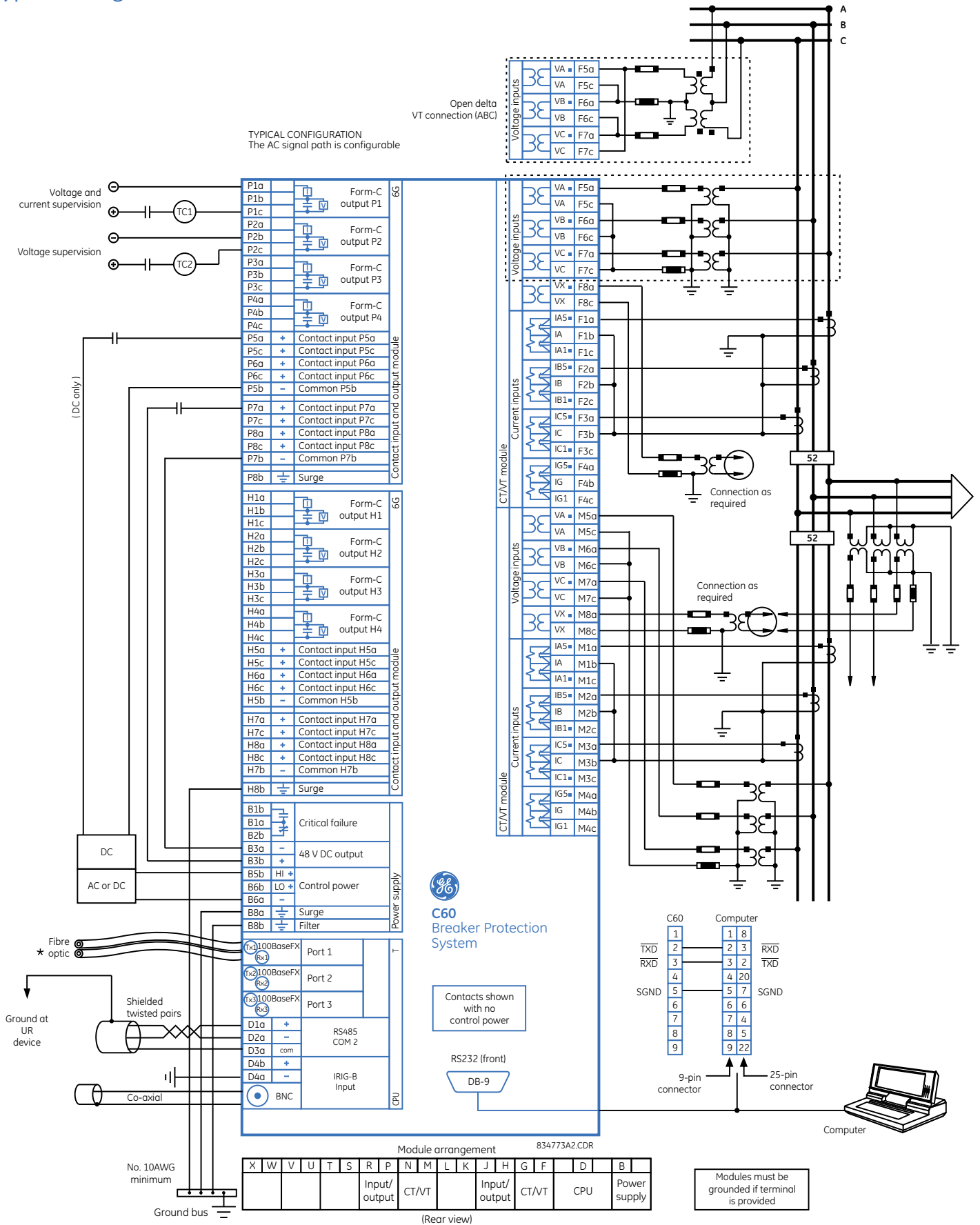

Ordering

	C60 - *	** - H	* - F	** - H	M** - P**	- U**	- W**	
Base Unit	C60	** - V	F	* - F	** - H	M**	- P**	- U**
CPU	C60	T U V W						
Software Options ¹		00 01 03 04 14 15 A0 B0 C0 D0 M2						
Mount		H A V B						
User Interface			E F I J K L M N O Q T U V W Y H O Z X					
Power Supply ²			H H L				RH	
CT/VT DSP				8L 8M 8N 8R		8L 8M 8N 8R		
IEC 61850 Process Bus ^{4,5}					81 85 86 87			
Digital I/O					XX 4A 4C 4L 67 6C 6D 6E 6F 6K 6L 6M 6N 6P 6R 6S 6T 6U 6V 6W	XX 4A 4C 4L 67 6C 6D 6E 6F 6K 6L 6M 6N 6P 6R 6S 6T 6U 6V 6W	XX 4A 4C 4L 67 6C 6D 6E 6F 6K 6L 6M 6N 6P 6R 6S 6T 6U 6V 6W	
Transducer I/O					5A 5C 5D 5E 5F	5A 5C 5D 5E 5F	5A 5C 5D 5E 5F	5A 5C 5D 5E 5F
Inter-Relay Communications							2B 2I 2J 7B 7C 7H 7I 7J 7S 7W 77	

For Full Sized Horizontal Mount
For Reduced Size Vertical Mount

Base Unit
RS485 + three multimode SFP LC 100BaseFX
RS485 + two multimode SFP LC 100BaseFX + one SFP RJ45 100BaseT
RS485 + three SFP RJ45 100BaseT
RS485 + two 100BaseFx Eth, Multimode ST + one 10/100BaseT Eth, RJ-45³

No Software Options
Ethernet Global Data
IEC 61850
Ethernet Global Data
2 x PMU
IEC 61850 + 2 x PMU
CyberSentry UR Lvl 1
IEEE 1588
PRP
IEEE 1588 + CyberSentry UR
IEC 61850 + 2 x PMU + 61850-90-5

Horizontal (19" rack) - Standard
Horizontal (19" rack) - Harsh Chemical Environment Option
Vertical (3/4 size) - Standard
Vertical (3/4 size) - Harsh Chemical Environment Option

7" Graphical display, USB front port & programmable pushbuttons - Multi-Language (FW 7.6x or higher)
Vertical Front Panel with English Display
Enhanced German Front Panel
Enhanced German Front Panel with User-Programmable Pushbuttons
Enhanced English Front Panel
Enhanced English Front Panel with User-Programmable Pushbuttons
Enhanced French Front Panel
Enhanced French Front Panel with User-Programmable Pushbuttons
Enhanced Russian Front Panel
Enhanced Russian Front Panel with User-Programmable Pushbuttons
Enhanced Chinese Front Panel
Enhanced Chinese Front Panel with User-Programmable Pushbuttons
Enhanced Turkish Front Panel
Enhanced Turkish Front Panel with User-Programmable Pushbuttons
Enhanced Polish Front Panel³
Enhanced Polish Front Panel with User-Programmable Pushbuttons³
Enhanced Japanese Front Panel³
Enhanced Japanese Front Panel with User-Programmable Pushbuttons³

125 / 250 V AC/DC
125/250 V AC/DC with redundant 125/250 V AC/DC power supply
24 - 48 V (DC only)

Standard 4CT/4VT w/ enhanced diagnostics
Sensitive Ground 4CT/4VT w/ enhanced diagnostics
Standard 8CT w/ enhanced diagnostics
Sensitive Ground 8CT w/ enhanced diagnostics
8 Port IEC 61850 Process Bus Module
-9-2LE & 61869 Process Bus, 2 x 1000BaseF
-9-2LE & 61869 Process Bus, 4 x 1000BaseF + 4 x 100BaseFx
-9-2LE & 61869 Process Bus, 4 x 100BaseFx

No module
4 Solid State (No Monitoring) MOSFET Outputs
4 Solid State (Current w/opt Voltage) MOSFET Outputs
14 Form-A (No Monitoring) Latchable Outputs
8 Form-A (No Monitoring) Outputs
8 Form-C Outputs
16 Digital Inputs
4 Form-C Outputs, 8 Digital Inputs
8 Fast Form-C Outputs
4 Form-C & 4 Fast Form-C Outputs
2 Form-A (Current w/ opt Voltage) & 2 Form-C Outputs, 8 Digital Inputs
2 Form-A (Current w/ opt Voltage) & 4 Form-C Outputs, 4 Digital Inputs
4 Form-A (Current w/ opt Voltage) Outputs, 8 Digital Inputs
6 Form-A (Current w/ opt Voltage) Outputs, 4 Digital Inputs
2 Form-A (No Monitoring) & 2 Form-C Outputs, 8 Digital Inputs
2 Form-A (No Monitoring) & 4 Form-C Outputs, 4 Digital Inputs
4 Form-A (No Monitoring) Outputs, 8 Digital Inputs
6 Form-A (No Monitoring) Outputs, 4 Digital Inputs
2 Form-A (Cur w/ opt Volt) 1 Form-C Output, 2 Latching Outputs, 8 Digital Inputs
30 Contact Inputs - Pin Terminals³
18 Form-A (No Monitoring) Outputs - Pin Terminals³

4 dcmA Inputs, 4 dcmA Outputs
8 RTD Inputs
4 RTD Inputs, 4 dcmA Outputs
4 dcmA Inputs, 4 RTD Inputs
8 dcmA Inputs
IEEE C37.94, 1300nm, singlemode, ELED, 2 Channel
Channel 1 - IEEE C37.94, 820nm, multimode fiber, 64/128 kbps;
Channel 2 - 1300 nm, singlemode, LASER
Channel 1 - IEEE C37.94, 820nm, multimode fiber, 64/128 kbps;
Channel 2 - 1550 nm, singlemode, LASER
1300 nm, multimode, LED, 1 Channel
1300 nm, singlemode, ELED, 1 Channel
820 nm, multimode, LED, 2 Channels
1300 nm, multimode, LED, 2 Channels
1300 nm, singlemode, ELED, 2 Channels
G.703, 2 Channels
RS422, 2 Channels
IEEE C37.94, 820 nm, multimode, LED, 2 Channel

Ordering Notes:

- To view all the options available for C60, please visit GE's On-Line Store at <http://store.gedigitalenergy.com/viewprod.asp?model=C60>
- Redundant power supply only available in horizontal unit. If redundant is chosen, must be same type. Maximum 2 per chassis
- Option available soon
- Process bus module requires empty slots next to it.
- Conventional DSP and Process Bus modules cannot run simultaneously

GEGridSolutions.com

IEC is a registered trademark of Commission Electrotechnique Internationale. IEEE is a registered trademark of the Institute of Electrical Electronics Engineers, Inc. Modbus is a registered trademark of Schneider Automation. NERC is a registered trademark of North American Electric Reliability Council. NIST is a registered trademark of the National Institute of Standards and Technology.

GE, the GE monogram, Multilin, FlexLogic, EnerVista and CyberSentry are trademarks of General Electric Company. GE reserves the right to make changes to specifications of products described at any time without notice and without obligation to notify any person of such changes.

Copyright 2023, General Electric Company. All Rights Reserved.

