

Multilin D400



Advanced Substation Gateway Secure, Consolidated Substation Communications

GE's Multilin™ D400 is a secure, substation-hardened gateway that collects metering, status, event, and fault report data from serial or LAN based Intelligent substation devices. The D400 summarizes data from the substation devices and makes it available locally/remotely through a standard secure web browser (HTTPS).

It supports serial and/or LAN connections to SCADA masters. TCP/IP network connections are supported over the built-in Ethernet and the modem interface.

Key Benefits

- Increased operational and non-operational analog data management through Analog Report Generation capability
- Increased availability and reliability of data through the presence of a third Ethernet interface, hot-standby functionality and Parallel Redundancy Protocol (PRP), IEC® 62439-3 Ed 2 scheme
- Direct support for industry standard communication protocols (including IEC 61850) ensures connectivity with new and legacy substation devices and master stations
- Advanced security features including remote User Authentication, access control, and auditing to ensure compliance with NERC®/CIP® requirements
- Full suite of SCADA® protocols allow for direct communications with Master Stations
- Secure pass through / terminal server, with support for SSH and TLS, allowing personnel to access substation devices locally or remotely.
- Graphical configuration with drop downs and pre-configured device maps reduces setup and configuration time
- Application flexibility with complete IEC 61131 SoftLogic Capabilities
- Enable predictive maintenance with local or remote access to device status, annunciator, and data log
- Advanced HMI including File Explorer interface and streamlined Alarm page, simplifying device and system management
- Offline editor and secure LogicLinx connection provides simplified device configuration utilizing powerful SGConfig software toolset

Applications

- **Advanced Gateway** – Substation Data collection, concentration and visualization Advanced Automation
- **Advanced Automation** – Automate substation procedures using IEC 61131 compliant tools
- **Fault Recording & Data Logging** – Extract valuable data such as digital fault records and event files
- **Secure Remote Access** – Securely access substation device locally and remotely



imagination at work

Advanced Automation

- Built-in alarm annunciator & one line diagrams editor
- IEC 61131 soft logic using LogicLinx™
- Analog/Digital data logging

Security

- Centralized user authentication (LDAP, TACACS+ and RADIUS) with local and remote Syslog auditing
- Role based access control & secure access via SSH/SFTP/SCP/HTTPS/TLS
- Secure tunneling from master station to the D400 via TLS for DNP3/TCP, Modbus/TCP and IEC 104
- Secure file transfer, over SSH, to enterprise server using "Rsync" push mechanism

Connectivity

- Simultaneous SCADA protocols and firmware
- Up to 16 RS232/RS485 serial ports & 64 virtual serial ports
- Supports IEC 62439-3 Parallel Redundancy Protocol (PRP)
- Analog report generation and automatic record retrieval via TFTP, FTP, SFTP, 61850 MMS, and SEL ASCII
- Retrieval of ARR data and IED status to Tarigma™ Grid Enterprise Manager (GEM)
- Custom IP routing to different master devices

Hardware

- Dual hot swappable power supplies
- Built-in Ethernet switch (2 or 4-ports)
- 3 Independent Ethernet interfaces (IP & MAC addresses)
- Optional D.20 RIO to interface with D20 I/O

Overview

GE's Multilin D400 is a secure, hardened, advanced substation gateway that collects metering, status, event, and fault report data from serial or LAN based intelligent substation devices. The Multilin D400 summarizes data from the substation devices and makes it available locally /remotely through a standard secure web browser (HTTPS). It supports serial and/or LAN connections to SCADA masters. TCP/IP network connections are supported over the built-in Ethernet and the modem interface.



Advanced Gateway

The Multilin D400 collects data from substation protection, control, monitoring, RTU, and intelligent devices, pre-processes the data and moves it up to EMS and DMS SCADA systems providing centralized substation management. Gateway features include:

- Data collection, concentration and visualization
- IEC 61850 Gateway
- Device Redundancy
- Built in Media Conversion



Advanced Automation

The Multilin D400 provides the computing platform necessary to automate substation procedures, such that intricate processes are carried out safely and efficiently by creating custom automation programs using IEC 61131 compliant tools, and perform basic math functions on data points using the built-in calculator tool. Automation features include:

- HMI, One Line Viewer and Annunciator
- Mathematical Control Logic
- Programmable Logic using LogicLinx
- Accumulator Freeze
- Analog Value Selection
- Control Lockout
- Double Point Association
- Input Point Suppression
- Redundant I/O
- Alarm Management



Fault Recording/Data Logging

Using pass-through connections, users can extract valuable non-operational data such as digital fault recording (DFR) records, event and oscillography* files. The user can also access the historical log files and upload the archived data for trending and analysis. Fault recording features include:

- Data Logger
- Trend Viewer
- Data Base Exporter



Secure Remote Access

The Multilin D400 allows maintenance and relay engineers to securely access substation devices, locally or remotely, through advanced visualization and communication tools, increasing productivity. Secure remote access features include:

- Access to Operational and Non-operational Data
- Pass-through/Terminal Server
- Role Based Access Control
- Virtual Serial Ports

Multilin D400 Applications

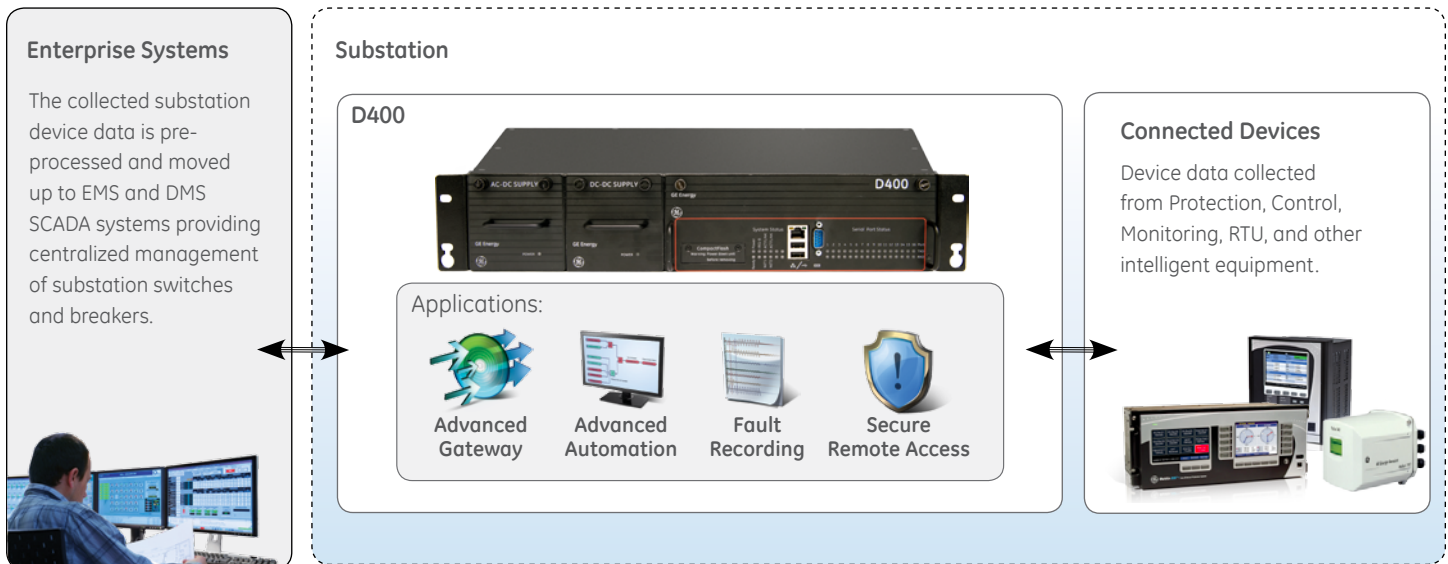



Advanced Gateway

Data Collection, Concentration and Visualization

The Multilin D400 advanced substation gateway, when operating as a SCADA host, collects, filters, and sorts data from a wide range of intelligent devices (RTUs, relays, meters) in the substation and preserves original data time stamp for accurate sequence of event. Data can be presented to multiple SCADA hosts. The D400 comes with a built-in suite of protocols and security applications to facilitate communication with various substation devices and SCADA hosts, including:

- DNP3 serial and TCP/IP (client & server)
- IEC 61850 (client)
- Modbus™ serial & TCP/IP (client & server)
- IEC60870-5-101/103/104 (client)
- IEC60870-5-101/104 (server)
- SELFast Meter/SEL ASCII
- Hydran™ Host*
- GE modem
- Generic ASCII protocols

IEC 61850 Gateway

The IEC 61850 Client application allows the Multilin D400 to act as a powerful IEC 61850 data concentrator. The D400 also includes valuable features such as Dynamic Data Sets, Buffered Control Blocks, and Enhanced Security Controls.

Device Redundancy (Hybrid Model)

Dual Multilin D400 units can be deployed creating a redundant system where accumulators, SOE logs, and configurations are automatically synchronized between the two systems. Serial communication links are automatically switched between the units based on system health.

The D400 100Base-FX redundant Ethernet card enables automatic switchover between two sets of Ethernet switches ensuring there is no single point of failure in the system.

The D400 supports three modes of operation:

- Standalone
- Warm Standby and
- Hot Standby

The D400 can be configured to operate in one mode at any given time.

The following D400 applications are supported under the Hot standby mode of operation:

- Calculator
- Modulus Client
- DNP 3.0 Server
- DNP 3.0 Client
- D.20 Network Client
- Digital Event Manager
- IEC 61850 Client
- D400 Event Logger
- Logiclinx IEC 61131-3 SoftLogic
- D400 Redundancy Manager
- D400 System Status Manager
- D400 Terminal Services
- Firewall
- Secure Enterprise Connectivity

Advanced Substation Gateway Connectivity

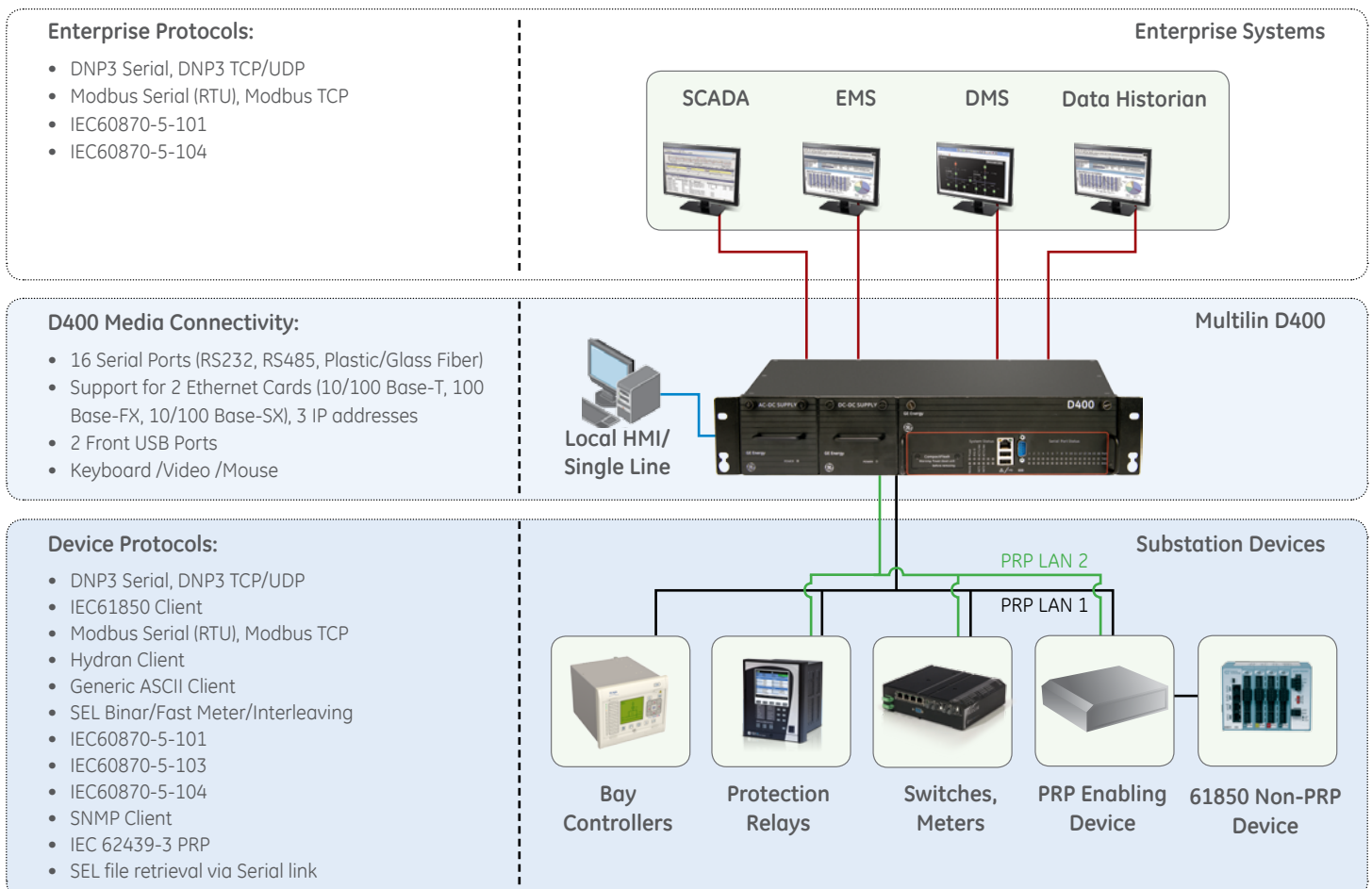

Built-in Media Conversion

The Multilin D400 supports various communication media types—Serial: RS-232, RS-485, Glass Fiber, and Plastic Fiber; and Ethernet: 10/100Base-T, 10Base-FL, and 100Base-FX. Hot swappable communications modules eliminate the need for dongle type media converters used to convert to glass or plastic fiber, reducing total cost of deployment.

IEC 62439-3 (Edition 2), Parallel Redundancy Protocol

Substation LAN redundancy has been traditionally accomplished by reconfiguring the active network topology in case of failure. Regardless of the type of LAN architecture (tree, mesh, etc.), reconfiguring the active LAN requires time to switchover, during which the LAN is unavailable.

Parallel Redundancy Protocol is an IEC 62439-3 data communication network standard which is often used to overcome single network failure without affecting the data transmission. PRP is independent of the communication protocols and provides no packet loss (“zero recovery time”) availability by using connected nodes which transmit and receive over two

independent network active paths. Under PRP, each network node has two Ethernet ports attached to two different local area networks, using standard bridges, and similar topology.

Existing D400 systems with 1 GHz or newer CPU can be upgraded via firmware in order to enable the Parallel Redundancy Protocol.

The D400 can communicate simultaneously to devices connected to a common network, carrying mixed traffic: single LAN, legacy redundant or dual LAN, and PRP. This aids in implementing PRP in brown field installations, taking advantage of possible spare ports on existing managed switches LAN infrastructure. Additional LAN switches may be added as needed.

Analog Report Generation

In addition to the data logging capability within the D400, users can configure the D400 to record and generate online and offline reports from operation and non-operation analog data. While online reports can be retrieved instantly and are an extension of the data logger periodic reports, offline reports can be retrieved daily, weekly or monthly.

Offline Reports:

- Users can use the Analog report application to generate offline reports
- Users can configure different types of analog reports. For example: Shift, daily, weekly and monthly
- Users can use the offline report viewer to view generated reports
- Output format types includes: PDF, Excel® and HTML

Online Reports:

- This is an extension of the data logger periodic reports
- Users can use the online report viewer to view periodic data logger reports
- Output format types includes: PDF, Excel® and HTML

Report Configuration Steps:

1. Create report template using iReport Designer
2. Import template to D400
3. Configure Offline Reports

Types of Offline Reports and Key Parameters:

REPORT TYPE	REPORT DURATION	START TIME ALIGNMENT	LOGGING INTERVAL	LOGGING ALIGNMENT
Shift	Configurable 4, 6, 8 or 12 hours	Configurable 0-23 hour	Configurable 15, 30, 60 minutes	Configurable 00:00, 00:15, 00:30 or 00:45
Daily	Fixed 1 day	Configurable 0-23 hour	Configurable 15, 30, 60 min and 4, 6, 8 hours	Configurable 00:00, 00:15, 00:30 or 00:45
Weekly	Fixed 7 days	Configurable 0-23 hour	Configurable 12 and 24 hours	Configurable 0-23 hours
Monthly	Fixed 7 days	Configurable 1-31 date	Configurable 12 and 24 hours	Configurable 0-23 hours



Advanced Automation

The Multilin D400 acts as the centralized, rugged computing platform in advanced automation systems. Using the calculator tool and/or GE's programmable logic (LogicLinx), users can create custom automation programs for a variety of applications such as:

- Sequence Switching
- Interlocking
- Auto-sectionalizing
- Auto-reclosing
- Load Tap Changer Control
- Cap. Bank Control
- Reactor Switching
- Alarm Grouping

HMI, One Line & Annunciator

The Multilin D400 supports a web based HMI/Annunciator feature, that is accessible using a standard Internet browser or through a VGA monitor and USB keyboard/mouse attached directly to the unit. Users have access to all data points in the systems, alarm screens, communications status screens and dynamic one line diagrams, all through the secure web interface.

The web based HMI supports the following security features to ensure secure remote or local access:

- Configurable auto logout/login for Remote and Local HMI access
- Disabling of Remote HMI Non-Observer Privileges
- Login to specific custom screens for added security to sensitive displays
- Remote access to Redundant or Active HMI screens

Mathematical Control Logic

Using the calculator tool, users can create advanced solutions that group, manage and control points to produce the required automation results.

The calculator tool can perform mathematical, logical, or timer based operations on data points stored in the Multilin D400. Using a graphical interface, users can define logical expressions using mathematical functions such as; addition, multiplication, logarithm, greater than, less than, as well as other boolean functions.

Programmable Logic (LogicLinx)

For more advanced applications, programmable logic (LogicLinx) software provides PLC functionality on the D400 platform. LogicLinx offers textual and graphical languages defined in the IEC 61131-3 standard for PLC programming

environments, including Sequential Functions Chart, Instruction List, Structured Text, Ladder Diagram and Function Block Diagram. In addition, a wide range of arithmetic, boolean and logical operations are supported.

Accumulator Freeze

Define groups of accumulator points whose values are frozen periodically or on demand.

Analog Value Selection

Define a group of prioritized analog input points with the highest priority, valid input being reported to a single analog input point.

Control Lockout

The Control Lockout feature ensures that only a single master station can access a group of controls at one time, and can lock out groups of controls to allow for safer local maintenance. Users can create up to 8 remote control groups and up to 256 local control groups. Any digital output can be included in one remote and one local group.

Double Point

Associates two digital input points to form a double point indication. Also known as 4-state points.

Input Point Suppression

Suppress reporting of input points while they are unavailable during maintenance. This allows users to disable groups of analog and digital input points by ignoring their actual data and quality changes within selected applications. While points are suppressed, a predefined suppression value and the Point Suppressed quality flag are provided instead. This is useful during maintenance operations to prevent spurious OFFLINE alarms and false readings while devices are powered off or disconnected.

Redundant I/O

Specify a secondary data point for any point that is used to report the value and quality when the associated primary point is invalid or questionable.

Alarm Management

The D400 Alarm groups are user-definable, with up to 256 groups allowed. Each group has its own descriptive and display parameters. Alarms may belong to more than 1 group, or none at all. "Critical" and "Default" groups are built-in. SCADA points for the alarm groups remain on-line if component alarm points go offline. SCADA points are provided to acknowledge a group of alarms. Individual alarms must be acknowledged via the D400 GUI.

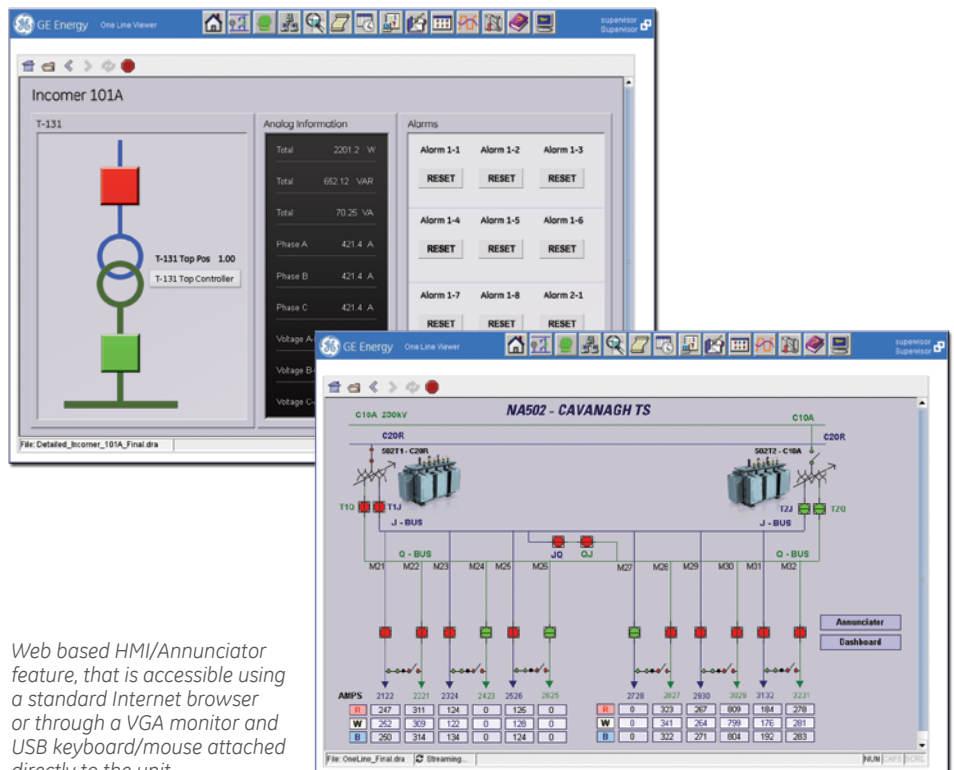

Web based HMI/Annunciator feature, that is accessible using a standard Internet browser or through a VGA monitor and USB keyboard/mouse attached directly to the unit.



Fault Recording/ Data Logging

The Multilin D400 can automatically retrieve event and oscillography files from devices such as Multilin UR Protective Relays, GE's D25 Controllers, and IEC 61850 server devices. Using IEEE file naming standards, these event files are renamed and can be stored locally or securely sent to corporate servers using Rsync (SSH).

Data Logger

The Analog Data Logger provides a variety of means to monitor and record analog input point value changes into data files that can be retrieved by the user. A variety of recording methodologies are supported including, Continuous (all changes), Periodic, Time Weighted, Out of Range and Triggered by a digital input point.

Trend Viewer

All data recorded by the Analog/Digital Data Logger can be viewed by the Digital event recorder using the built in web-based Trend Viewer. Users can select the range of data to be used by time and date, alternately a real time streaming view can be displayed. Up to 8 data points (pens) can be displayed on a single view and support for curve fitting is available.

Database Exporter

The Database Exporter tool allows users to save Analog Data Logger and Digital event recorder points from the Multilin D400 to your local PC, using the WEB interface, in comma-separated values (CSV) format.

Automatic Record Retrieval

The Automated Record Retrieval Manager (ARRM) retrieves and stores record files from devices connected to the D400.

ARRM uses the Distributed Network Protocol (DNP) and the IEC 61850 protocol to communicate with a variety of devices, and uses the Trivial File Transfer Protocol (TFTP) or MMS to transmit the files from the IED to the device over a Local Area Network (LAN) or serial connection.

You can also retrieve downloaded records from the D400 using any FTP/SCP/SFTP client as needed or on a scheduled basis.

ARRM supports a configurable interval for polling connected devices. This can be activated or deactivated through the runtime viewer display screen.

The connection status of the devices, in addition to the data retrieved from the IEDs can also be displayed or made available directly to the Tarigma Grid Enterprise Manager (GEM) software.

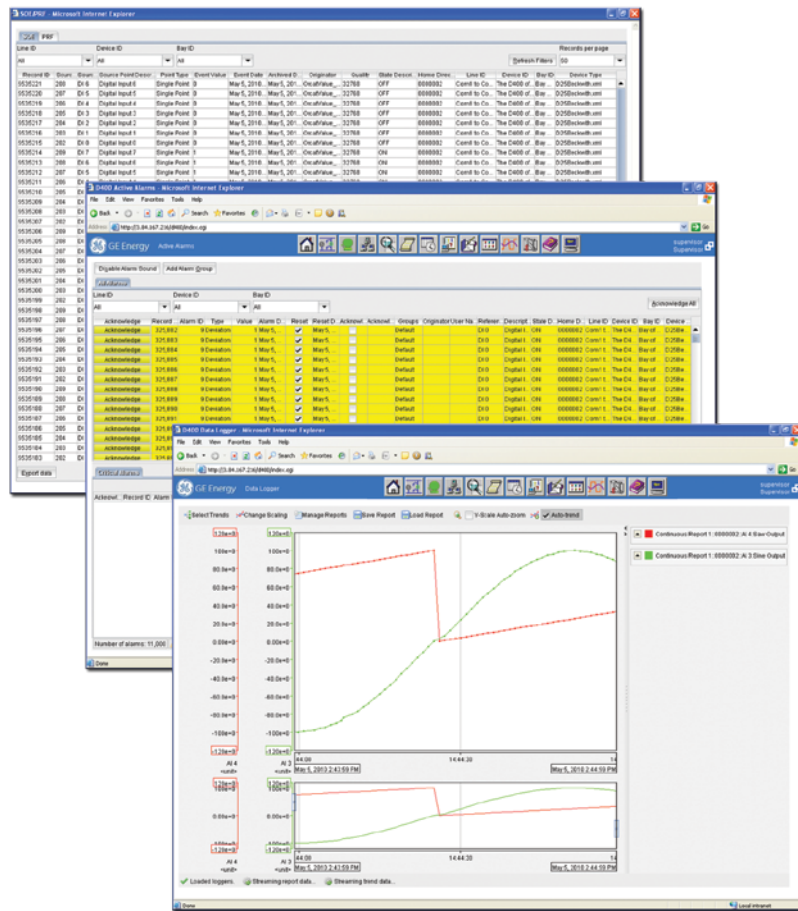

Multilin D400 Fault Recording

The D400 fault recording capability allows system event information to be collected and viewed using a web-based trend viewer.

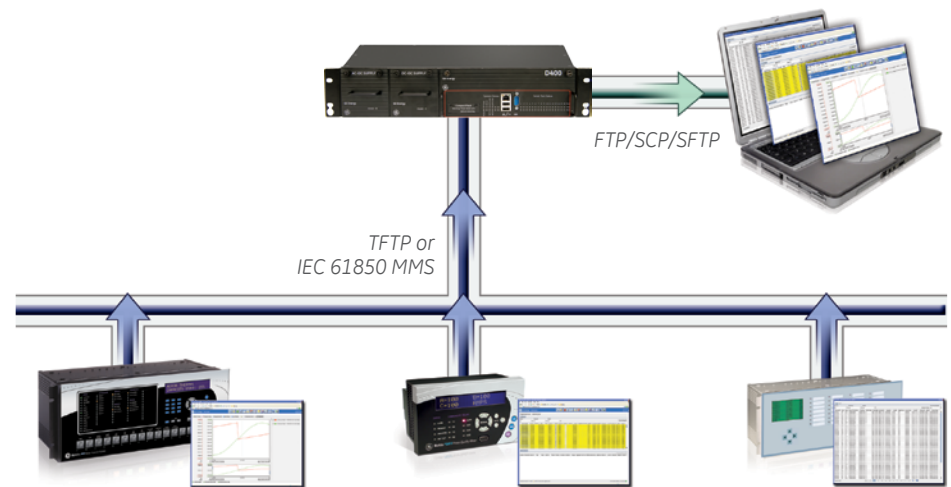



Secure Remote Access

Multilin D400 provides robust security environment, providing seamless integration with existing IT department policies. Role based Access Control, Secure Web Interface, Secure File Transfer, and extensive user activity logging provide a complete security toolkit required to achieve NERC-CIP compliance.

Non-operational Data

Using pass-through connections, the utility user can extract valuable non-operational data such as digital fault recording (DFR) records and event files. The user can also access the historical log files and upload the archived data for trending and analysis.

Pass-through/Terminal Server

A built-in terminal server emulator allows pass-through connections to be initiated to substation device (relay, meter, RTU or other device). Once the connection is established, the local event records can be uploaded from the substation devices and viewed remotely. Remote access can be secured with TLS or SSH.

Virtual Serial Ports

Virtual serial ports eliminate copper wire communications to feeder bays when a serial-only device is located in the bay. A small terminal server can be placed in the bay and connected to the Ethernet network, allowing all Multilin D400 serial client applications to connect directly to the serial device.



Use device software to obtain non-operational data such as trending and event records through the D400's secure remote access functionality.

Role Based Access Control

Role Based Access Control is achieved using LDAP, TACACS+, RADIUS or the D400's internal database; ensuring only authenticated and authorized users gain access the system. When using LDAP, TACACS+, RADIUS revoking user privileges, system wide, is as simple as updating the centralized user database.

Network security protocols:

- HTTPS
- SFTP
- LDAP
- SSH
- CHAP
- TLS
- SCP
- RADIUS
- Syslog
- TACACS+

Built-in Firewall

Multilin D400 is equipped with a built-in firewall for enhanced gateway cyber security. D400's firewall is designed to drop unsolicited or invalid routed packages.

The firewall is preconfigured to block outbound traffic on external interfaces and inbound traffic on both internal and external interfaces. The D400 automatically generates rules allowing inbound traffic on internal interfaces for all configured services. The rules are user configurable for inbound/outbound traffic customization.

Secure Remote Access

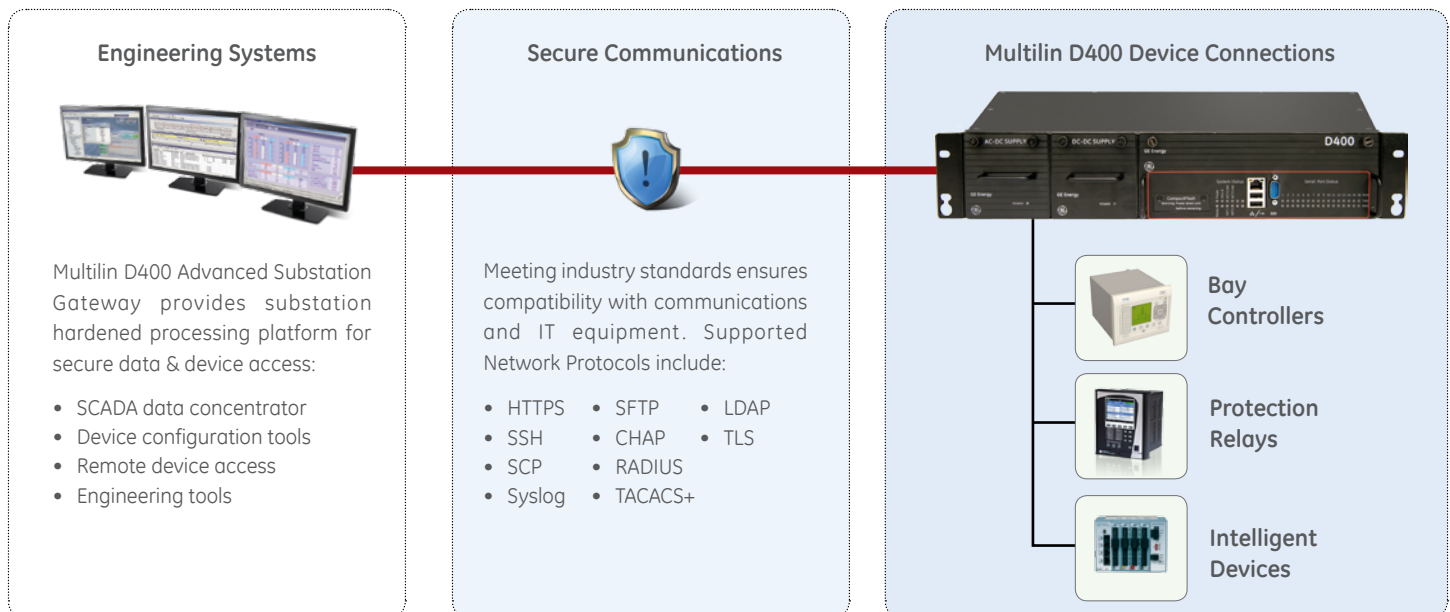

Configuration Software

IEC 61850 Substation Device Loader

A key benefit to using IEC 61850 based communications is the reduction in deployment costs for modern substation automation systems. The D400 IEC 61850 loader application guides users through a structured 4-step workflow to configure the IEC 61850 client application, reducing system configuration time.

Available device data, based on logical nodes, can be retrieved from the IEC 61850 Substation Configuration file (SCL files such as ICD, CID, SCD) or directly from the intelligent substation device using the IEC 61850 self-description.

The IEC 61850 device loader allows users to pick the specific logical nodes or data sets to be used for automation tasks or to be placed in the D400 database for upstream communications, reducing overall network traffic and system loading for increased system efficiency.

Using the IEC 61850 Dynamic Data Sets allows the configuration software to define the exact data to be retrieved from a substation device when initializing communications with that specific device. This allows users to configure the data sets through a single application rather than manually configuring data sets in each separate device, reducing mapping errors.

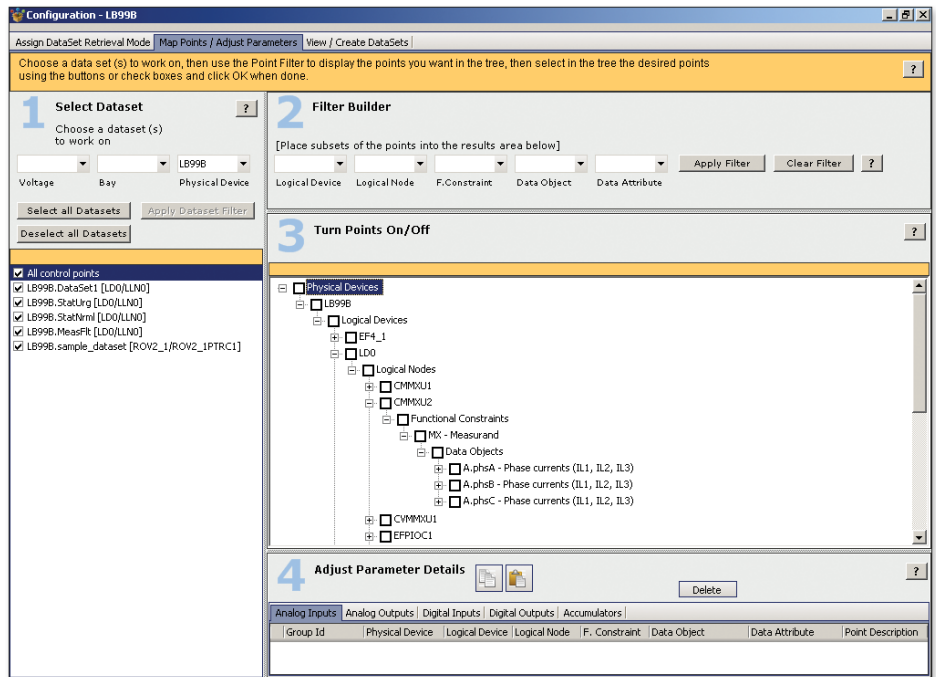

The IEC 61850 client is configured using the D400 Device loader application.

Device Configuration

Configuring the Multilin D400 to communicate with substation devices is simple and straightforward. Thanks to pre-configured map files, adding devices to the system only takes a few mouse clicks. Point maps can be customized to meet your specific needs, then applied for all devices requiring the modifications.

Creating One-Line diagrams is quick and easy using the built-in, drag and drop One-Line designer application. Configuring alarm and alarm groups is simplified using a tree view point selection tool.

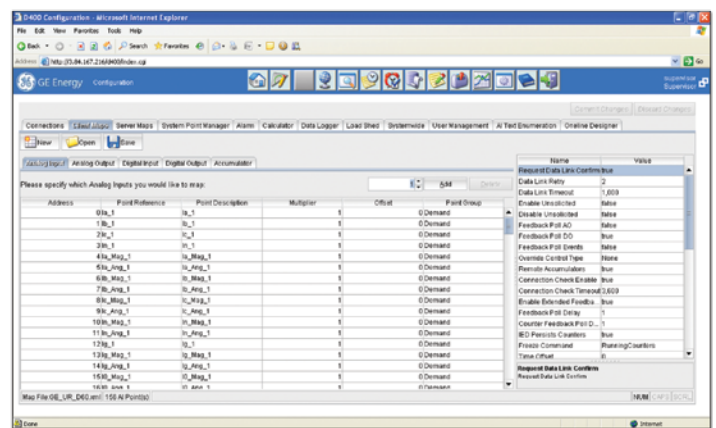
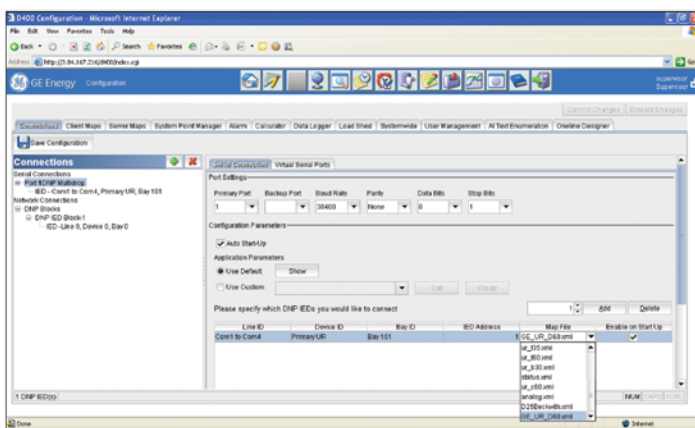

Browser-based configuration: connecting and configuring substation devices is simple using pre defined drop down lists of device point maps.

Hardware Overview

The D400 is built on a flexible, high performance, expandable diskless and fan-less platform that is powered by a 1.6 GHz processor.

Two Ethernet networks are supported with separate multiport switches. An IRIG-B format time protocol input/distribution module is also supported. Isolated serial port media is selected for each pair of ports.

Redundant Power Supplies

The Multilin D400 has dual redundant, hot swappable power supplies, ensuring continuous uptime. Each power supply can be connected to a different source. As an example power supply 1 can be connected to Mains, while power supply 2 is connected to the battery system. Power Supply Health Monitoring raises a SCADA point alarm when either power supply fails. This allows an alarm to be transmitted to the EMS / OMS or DMS system, where a field personnel can be dispatched to replace the failed supply, all without service disruption.

Time Sync Support

The D400 has extensive support for various time sync methodologies and will accept time sync signals from SNTP/NTP Servers, IRIG-B (un-modulated/modulated), and SCADA

protocols. The D400 can also distribute this time sync information through its built-in IRIG-B distribution interface, SCADA protocols, and/or through the RS232 ports directly.



Redundant, hot-swappable power supplies.

Back Panel

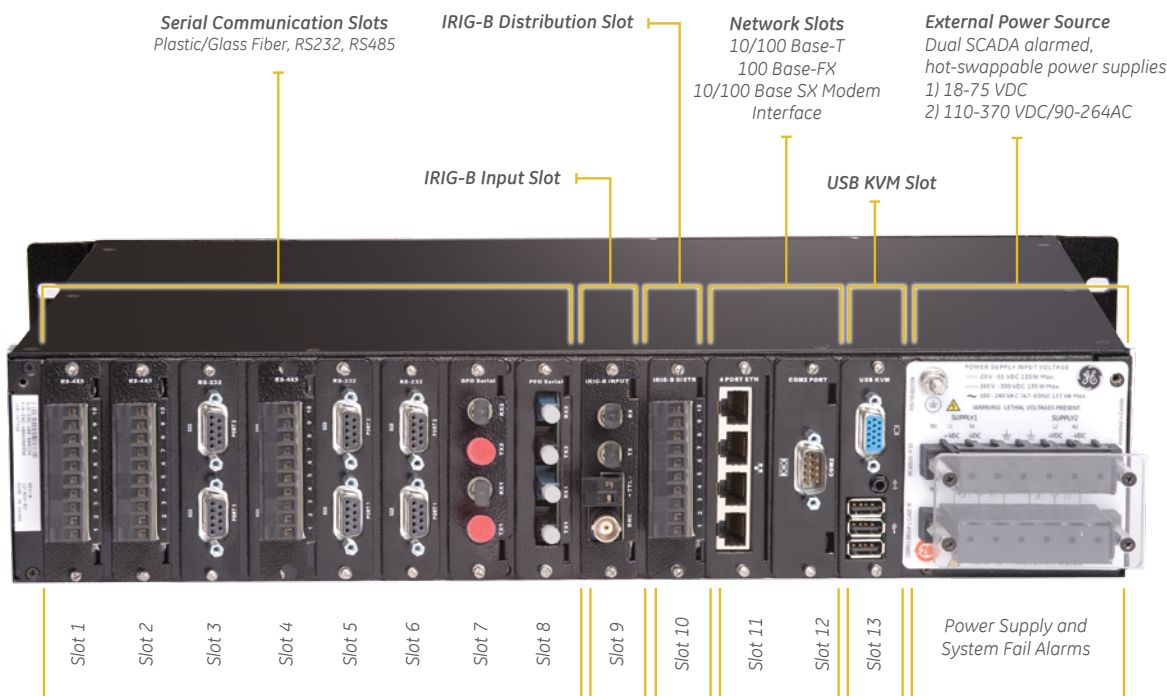

Front Panel

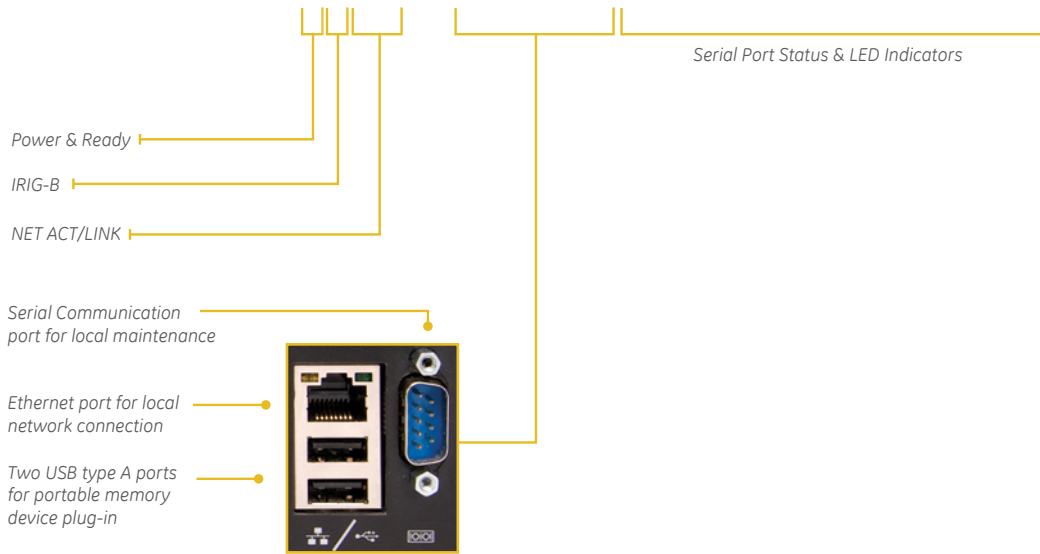
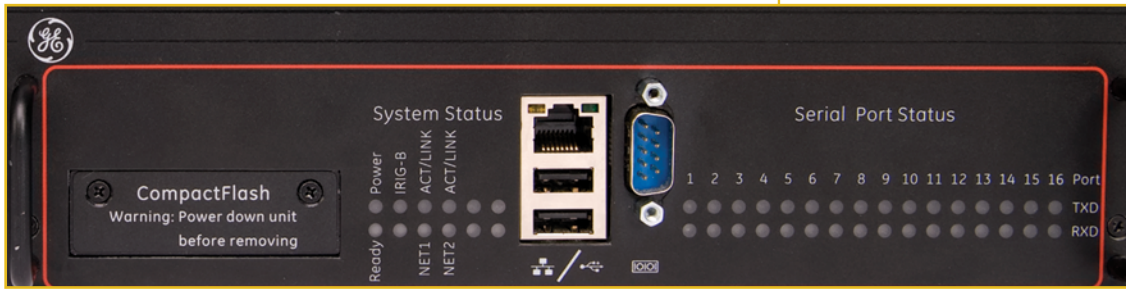
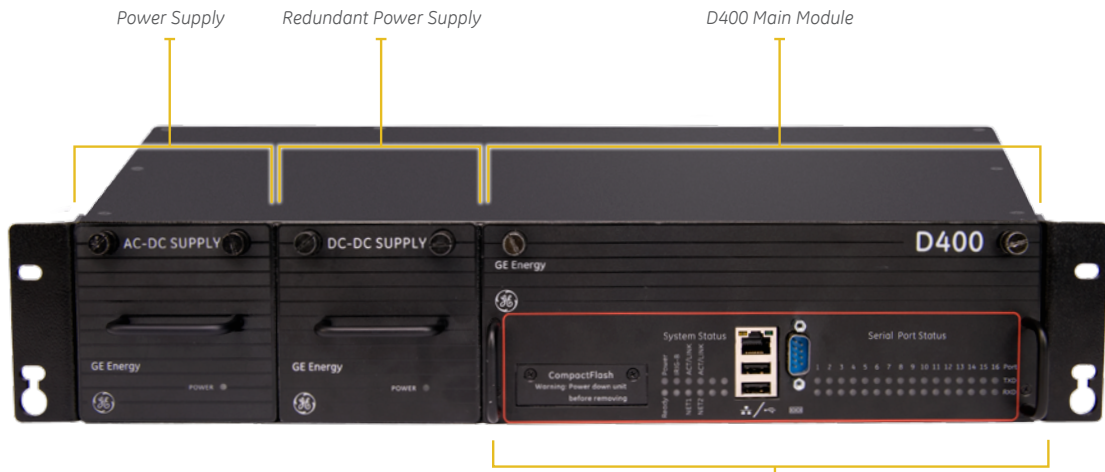

Technical Specifications

Processor, Memory, and Storage

1.6 GHz Embedded CPU with 33 MHz PCI bus

1.0 GB of DDR2 SDRAM

Industrial Grade Compact Flash Module (dual - 1.0 GB, expandable to dual 16 GB)

RTDB 10,000 SOE reports archived in an embedded SQL database
16 MB NVRAM standard for persistent event storage ensuring no loss of events

Communications

Ethernet – two Ethernet LAN supported (fiber and/or twisted pair) 10/100BaseT – 4 port integrated switch (isolated RJ-45 connector)
10Base-FL – redundant (fiber optic: 62.5/125 µm duplex fiber cable-ST connectors)
Wireless IP radio ready (via PPP serial port)
100BASE-FX redundant (fiber optic 1300nm duplex fiber cable-ST connectors)

Serial Communications (16 channels of RS-232/485/fiber optic) Data rate, 300 to 115.2 Kbps
RS-232

- Configurable for DCE/DTE operation
- Galvanic isolation between channels
- Can drive IRIG-B signal to RS-232 ports (with optional IRIG-B Input card present)

RS-485

- 2 Wire/4 wire support
- Galvanic isolation between channels
- Glass or plastic serial fiber port on ST connectors

IRIG-B

Input Module TTL (un-modulated), fiber optic (un-modulated), BNC (1 kHz modulated), CPU time sync for internal database time stamping

Distribution Module Can drive IRIG-B TTL signal for 16 Intelligent Devices
Signal Propagation Propagated to all 16 RS-232 ports for devices such as SEL[®] relays
Propagated to the distribution module

KVM

KVM Module Three USB ports for connecting keyboard and mouse
D-Sub 15 socket for connecting an industrial SVGA display
3.5 mm audio jack for substation alarms

Power Supply

Input Options: 20–55 VDC (+/- 10%), 100–240 Vac/100–300 Vdc (+/- 10%), 135 Watts DC Supply, 127VA AC Supply

Physical

Dimensions 19 Inch rack mount (482.59 mm)
2U (3.47" / 88.12 mm) in height
12.24" (310.95 mm) in depth
Mounting: 4 mounting holes, 2 slotted for easy installation

Environmental

Operating Temperature: -20° to +65°C operating range
Humidity: 5-95% relative humidity, non-condensing
Ingress Protection: IP30

Maintenance Software

OCM-Offline Configuration Manager**
System Requirements: IBM® PC or compatible computer, VT100 emulator

Configuration Software

OCM-Offline Configuration Manager
LogicLinx® Editor (if using LogicLinx)**
Web Browser-Based Online Configuration

Standards and Protection

CE Mark

2006/95/EC	LVD Directive
EN55011 (CISPR 11)	EMC Directive
EN61326	Electrical equipment for Measurement, control and laboratory use - EMC requirements

Emissions Standards

EN55011 (CISPR 11)	ISM RF Equipment - electromagnetic disturbance characteristics
IEC 60255-25	Electromagnetic emission tests for measuring relays and protection equipment
IEC 61000-3-2	EMC-limits for harmonic current emissions (equipment input current <16A per phase)
IEC 61000-3-3	EMC limits-limitations in voltage changes, voltage fluctuations and flicker in public low-voltage supply systems, for equipment with input current <16A per phase & not subject to conditional connection

Immunity Standards

IEC 61000-4-2, IEC 60255-22-2, IEEE C37.90.3	Electrostatic discharge (ESD) immunity test
IEC 61000-4-3, IEC 60255-22-3, IEEE C37.90.2* *(10V/m)	Radiated, radio-frequency electromagnetic field immunity test
IEC 61000-4-4, IEC 60255-22-4, IEEE C37.90.1	Electrical fast transient/burst immunity test
IEC 61000-4-5	Surge immunity test
IEC 61000-4-6	Immunity to conducted disturbances, induced by radio-frequency fields
IEC 60255-22-6	Electrical fast transient/burst immunity test
IEC 61000-4-8	Immunity to power frequency magnetic fields
IEC 61000-4-12	Oscillatory waves immunity test
IEC 60255-22-1, IEEE C37.90.1, Ontario Hydro A-28M-82	(Damped oscillatory and ringwave)

Safety Publications

IEC 61010-1	Harmonized safety standard
IEC 60255-5	Insulation coordination for measuring relays and protection equipment requirements and tests

Power Supply Standards

IEC 61000-4-11	AC power supply interruptions
IEC 61000-4-16	Immunity to conducted, common mode disturbances in the frequency range 0 Hz to 150 Hz
IEC 61000-4-17	Ripple on D.C. power supply
IEC 61000-4-29+ (+ HVDC only), IEC 60255-11	Voltage dips, short interruptions and voltage variations on D.C. input power port immunity test

Environmental Standards

IEC 60068-2-1	Environmental testing cold
IEC 60068-2-2	Environmental testing dry heat
IEC 60068-2-6, IEC 60255-21-1	Environmental testing vibration, Vibration tests (sinusoidal)
IEC 60068-2-27	Environmental testing shock
IEC 60068-2-29	Environmental testing bump
IEC 60068-2-30	Environmental damp heat cyclic (12+12 hour cycle)
IEC 60068-2-31	Environmental testing drop and topple
IEC 60255-21-2	Shock and bump tests

Communication Standards

IEC 61850-3	Substation comm. standard
IEEE 802.3	CSMA/CD access method and physical layer specifications

Ordering

Order Code Item	D400	*	*	*	-	*	*	*	*	-	*	*	*	*	-	*	*	*	-	*	*	*	-	*	*	U	*	Description
CPU OPTIONS	M N P Q																										1.6 GHz CPU, 1.0 GB DDR RAM, SINGLE ETHERNET 1.6 GHz CPU, 1.0 GB DDR RAM, DUAL REDUNDANT ETHERNET 1.6 GHz CPU, 1.0 GB DDR RAM, SINGLE ETHERNET, 16GB CF 1.6 GHz CPU, 1.0 GB DDR RAM, DUAL REDUNDANT ETHERNET, 16GB CF	
POWER SUPPLY	A B																										100-240 VAC (47-63 Hz), 100-300 VDC (10%) 20-55 VDC (10%)	
POWER SUPPLY (Redundant)	U A B																										NONE 100-240 VAC (47-63 Hz), 100-300 VDC (10%) 20-55 VDC (10%)	
SERIAL COMMUNICATION																											NONE D400 RS-232 IO ASSY D400 RS-485 IO ASSY D400 GLASS FIBER OPTIC IO ASSY D400 PLASTIC FIBER OPTIC IO ASSY	
IRIG-B INPUT CARD																											NONE IRIG-B INPUT CARD	
IRIG-B DISTR CARD																											NONE IRIG-B DISTRIBUTION CARD	
FIRST NETWORK SLOT																											1 2 4 5 ETHERNET 4 PORT 10/100 MB TP SWITCH ETHERNET FIBER OPTIC (HOT STANDBY) 2 PORT 10/100 BASE-SX ETHERNET REDUNDANT TP + COM2 D400 100BASE-FX HOT STANDBY ETHERNET	
SECOND NETWORK SLOT																											NONE ETHERNET 4 PORT 10/100 MB TP SWITCH ETHERNET FIBER OPTIC (HOT STANDBY) 2 PORT 10/100 BASE-SX MODEM PORT (REQUIRES EXTERNAL MODEM) D400 100BASE-FX HOT STANDBY ETHERNET ETHERNET REDUNDANT TP + COM2	
USB KVM, AUDIO																											NONE USB KVM & AUDIO CARD	
D400 LOCAL HMI (ONE-LINE VIEWER)																											NOT REQUIRED LOCAL HMI (BASIC)	
D400 IEC 61850																											NOT REQUIRED IEC61850 CLIENT APPLICATION	
LOGICLINX EXECUTOR LICENSE																											NOT REQUIRED D400 LOGICLINX EXECUTOR LICENSE	
D400 UTILITIES																											NOT REQUIRED D400 Utilities CD	
FIRMWARE IMAGE																											F J L K M N P FIRMWARE VERSION 3.20 FIRMWARE VERSION 3.20 + SERVICE PACK 2 FIRMWARE VERSION 3.20 + SERVICE PACK 3 FIRMWARE VERSION 5.01 FIRMWARE VERSION 5.10 FIRMWARE VERSION 5.11 FIRMWARE VERSION 5.20	
AUTOMATED RECORD RETRIEVAL MANAGER																											U A NOT REQUIRED AUTOMATED RECORD RETRIEVAL MANAGER LICENSE	

D400 Upgrade Kits

Order Code Item	D400-UGK	*	*	*	-	*	*	*	*	-	*	*	*	*	-	*	*	*	-	*	*	*	-	*	Description
CPU OPTIONS		U	U	U																					NO CPU REQUIRED 1.6 GHZ CPU, 1.0 GB DDR RAM
ETHERNET CONTROLLER OPTION		1	6	0																					NOT REQUIRED SINGLE ETHERNET CONTROLLER DUAL ETHERNET CONTROLLER
COMPACT FLASH OPTION (Redundant)																									NO CF REQUIRED 1GB SECONDARY COMPACT FLASH CARD (160-0141) 16GB SECONDARY COMPACT FLASH CARD (160-0142) 1GB PRIMARY / 1GB SECONDARY CF CARD (160-0141 & 160-0141) 1GB PRIMARY / 16GB SECONDARY CF CARD (160-0141 & 160-0142)
KEYBOARD VIDEO MOUSE (KVM) CARD OPTION																									NOT REQUIRED KVM CARD [520-0206]
D400 FIRMWARE OPTION																									FIRMWARE VERSION 3.20 FIRMWARE VERSION 3.20 + SERVICE PACK 2 FIRMWARE VERSION 3.20 + SERVICE PACK 3 FIRMWARE VERSION 5.01 FIRMWARE VERSION 5.10 FIRMWARE VERSION 5.11 FIRMWARE VERSION 5.20
SERVICE PACK OPTION																									NONE
SETUP SOFTWARE OPTION																									NO SETUP SOFTWARE DVD SGCONFIG V8.5 DVD [588-0082 V8.50/00] SGCONFIG V9.0 DVD [588-0082 V9.00/00]
MIGRATION SOFTWARE OPTION																									U C NO MGK USB REQUIRED D400 MIGRATION SOFTWARE V6.00 USB [588-0088/06]

GEGridSolutions.com

RADIUS Microsoft Active Directory is a registered trademark of the Microsoft Corporation. TACAS+ is a registered trademark of Cisco Systems, Inc. IEC is a registered trademark by Commission Electrotechnique Internationale. Modbus is a trademark of SCHNEIDER AUTOMATION INC. SEL is as a registered trademark by Schweitzer Engineering Laboratories, Inc. NERC is as a registered trademark of North American Electric Reliability Council. Tarigma Grid Enterprise Manager (GEM) is a trademark of Tarigma Corporation. IBM is a registered trademark of IBM Corporation.

GE, the GE monogram, Multiin, D400, D.20, LogicLinx and Hydran are trademarks of the General Electric Company.

GE Digital Energy reserves the right to make changes to specifications of products described at any time without notice and without obligation to notify any person of such changes.

© Copyright 2016, General Electric Company. All Rights Reserved.

GEA-12806(C)E
English
160822



imagination at work